



For Technical Support visit us at support.sunsetter.com,
e-mail contactus@sunsetter.com, or Call Toll Free 800-670-7071

EasyShade Solar Battery Replacement

For Solar-Powered EasyShades made 6/3/2024 - present

**⚠ WARNING! FAILURE TO FOLLOW THESE INSTRUCTIONS CAN RESULT IN PERSONAL INJURY!
PLEASE READ THESE INSTRUCTIONS COMPLETELY BEFORE PERFORMING THIS PROCEDURE.**

Tools Needed:

- Helper
- Ladder
- 5/64" Allen Wrench
- 3mm Allen Wrench
- 4mm Allen Wrench
- Masking Tape
- Flat Blade Screwdriver
- Phillips #2 Screwdriver
- 7/16" Open-End Wrench

Parts Supplied:

- Replacement Solar Battery

1. Close your EasyShade completely, if possible
2. Disconnect the power cord from the solar panel.

Note: If a Remote Wall Bracket (see Figure 1) is used to mount the solar panel directly to the wall (see Figure 2) instead of mounting directly on the EasyShade housing, skip ahead to Appendix A.

Figure 1

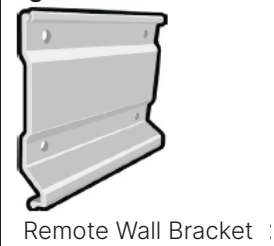
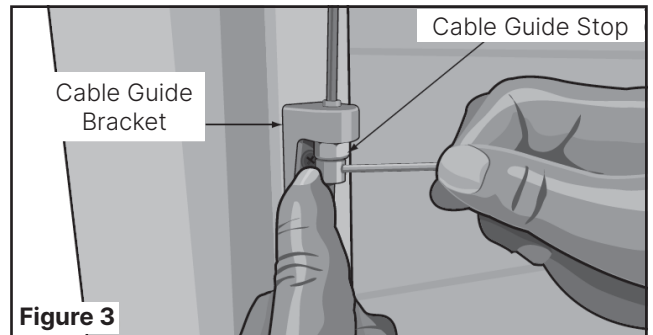
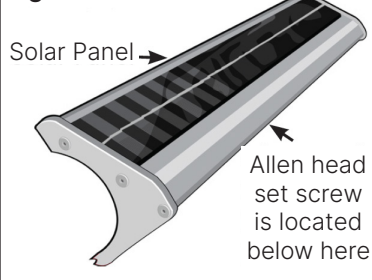
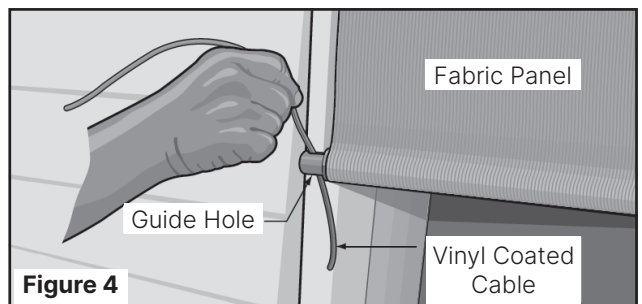

Figure 2



4. Pull the cables out of the cable guide holes on each end of solar screen fabric panel (see Figure 4).



3. Remove the cable guide stops from the bottom of the vinyl coated cables, on each side of the EasyShade, using a 5/64" Allen wrench (see Figure 3).

5. Coil the cables and secure with a piece of masking tape (see **Figure 5**).

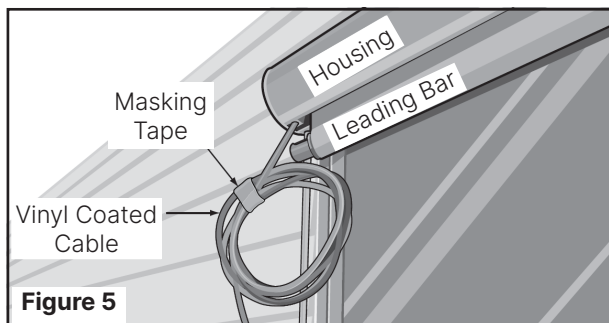

Note: Step 6 requires access to the mounting brackets for removal of the EasyShade from the house. If the fabric panel can not be retracted out of the way, have a helper assist you in rolling the fabric panel around the bottom leading bar until the rolled up fabric and leading bar meet the housing, then secure it safely in place.

6. While your helper supports the EasyShade, loosen the 3mm Allen head set screws on each mounting bracket (see **Figure 6**). With the aid of your helper, carefully remove the EasyShade from mounting brackets and place it in your work area.

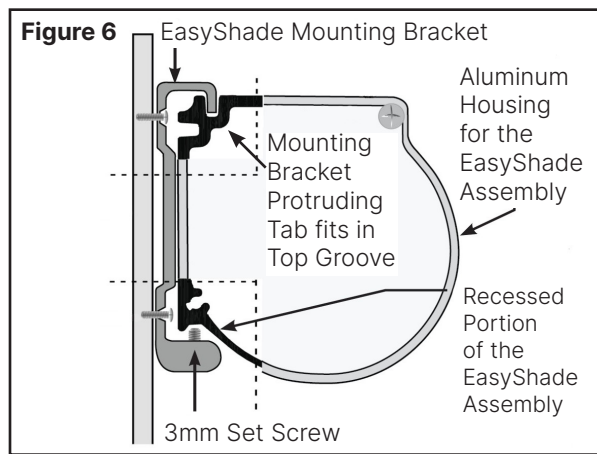

7. Remove the 4mm Allen head set screw securing the solar panel to the EasyShade housing (see **Figure 2**).

⚠ WARNING: HAVE A HELPER HOLD THE EASYSHADE STILL WHILE REMOVING THE SOLAR PANEL. FAILURE TO DO SO CAN RESULT IN DAMAGE TO THE EASYSHADE AND/OR PERSONAL INJURY.

8. Insert a flat blade screwdriver into the slot behind the top of solar panel, where it snaps onto the top of the EasyShade housing (see **Figure 7**).

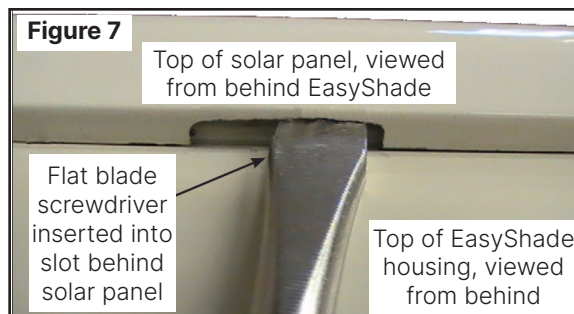

9. With the screwdriver inserted into the slot, pry the solar panel up and away from the EasyShade housing until the solar panel separates from the EasyShade housing (see **Figure 8**).

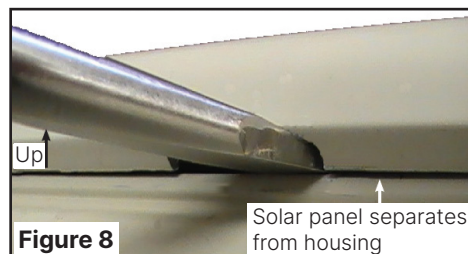

10. Remove all 4 Phillips screws from the **right side end cap** (see **Figure 9**).

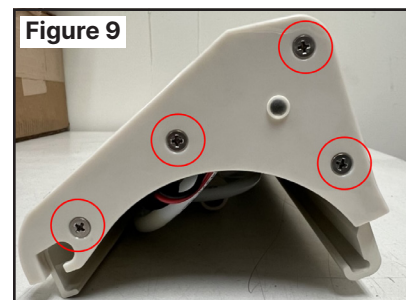

11. Remove the **right side end cap and gasket**.

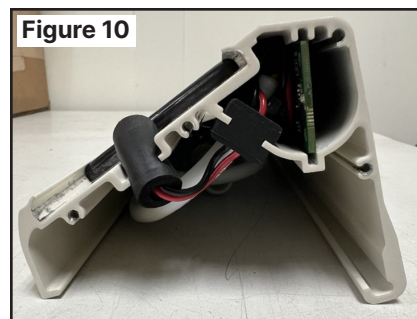

12. Slide the rubber grommet out and gently pull the PCBA (Printed Circuit Board Assembly) out of the extrusion (see **Figure 11**).

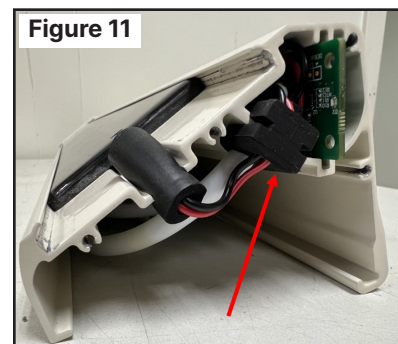

13. Disconnect the old battery and remove it from the extrusion.

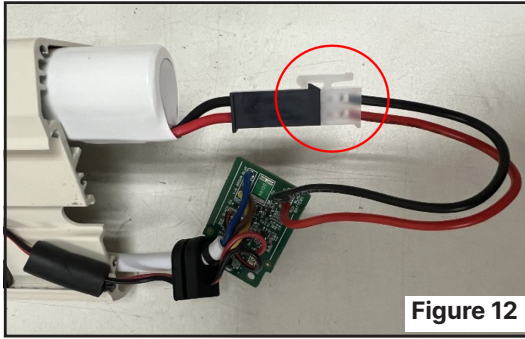

17. Make sure the PCBA is not protruding past the edge of the extrusion (see **Figure 16**).

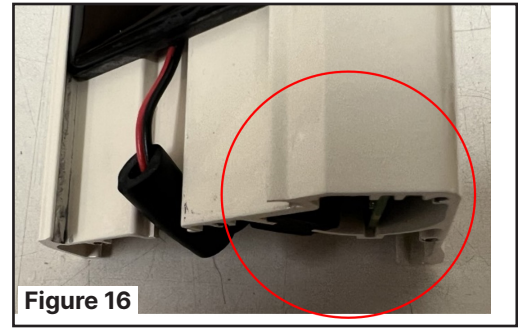

14. Insert the new battery into the extrusion and connect it to the PCBA.
a. The battery can only be inserted one way (see **Figure 13**).



18. Center the foam padding and insert it into the notch.

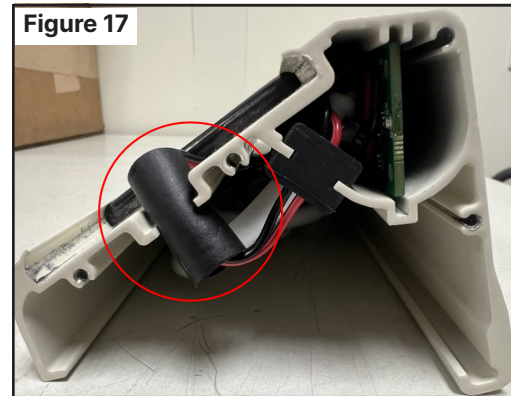

15. Gently guide the wires into the extrusion and slide the PCBA into the extrusion slots.

Note: Make sure the PCBA orientation matches **Figure 14**.

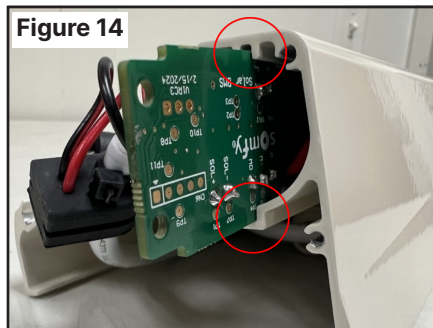

19. Make sure the end cap gasket is properly placed on the end cap (see **Figure 18**).

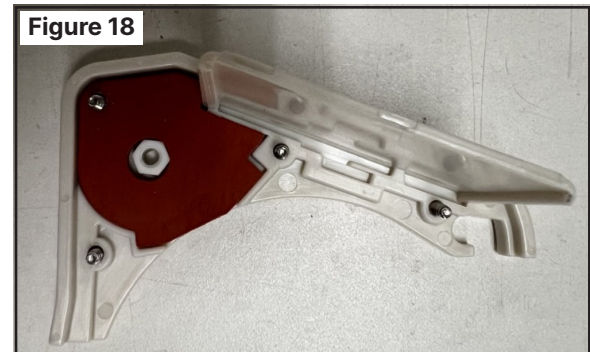

16. Slide the rubber grommet and PCBA back into the extrusion.

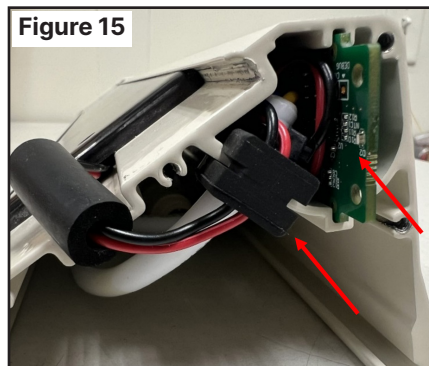

20. Slide the end cap into the extrusion and tighten the screws until the head of the screw touches the plastic. Then, turn the screw another 180 degrees.

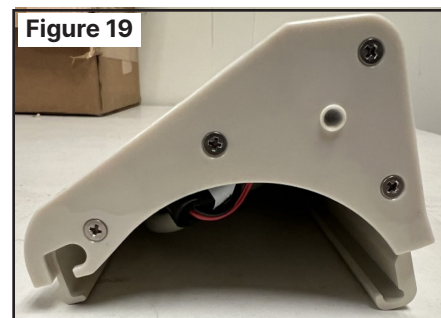

21. Reattach the solar panel to the EasyShade housing.
 - a. Before attaching the solar panel to the housing, make sure the solar panel cord is tucked into the cord slot so that it does not interfere with attachment (see **Figure 20**).
 - b. Hook the bottom edge of the solar panel under the front of the fabric panel opening of the EasyShade housing (see **Figure 20**).
 - c. Press the top of the solar panel firmly over the top front edge of the housing, until it snaps into place (see **Figure 20**).
22. Connect the motor power cord to the solar panel cord.

Note: Connectors are keyed to ensure proper alignment of pins in cable connectors.

Secure ends together using the screw locking mechanism on connectors.

Note: When positioning the solar panel on the housing, route the connected power cord behind the housing. Move the solar panel far enough away to remove slack in the power cord. The total length of the combined cord is about 4'. For narrow EasyShades, excess cord can be tucked behind the housing.

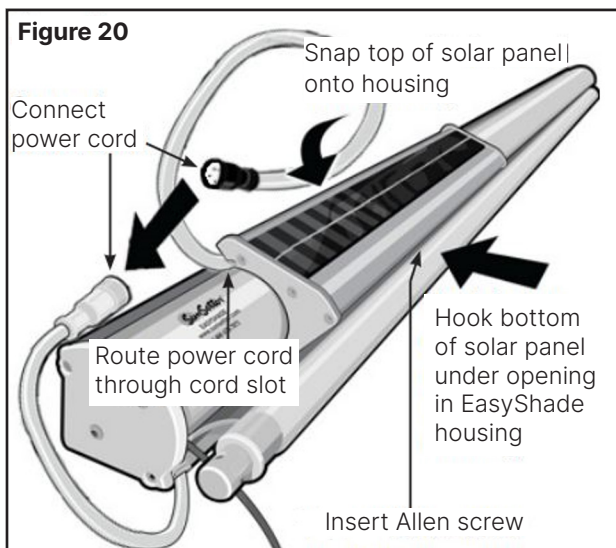

23. Secure the solar panel to the EasyShade housing by inserting and tightening the provided Allen head set screw into the threaded opening under the bottom edge of the solar panel.

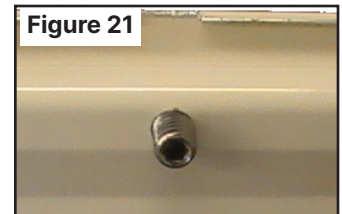

24. With your helper, lift the EasyShade back up to the installed mounting brackets and insert the top groove of EasyShade housing onto the mounting bracket protruding tab (see **Figure 6**).
 25. While maintaining upward pressure to keep the top groove of the EasyShade on the tab of the mounting brackets, press the EasyShade toward the mounting brackets and be sure that the set screw is aligned in the recessed portion of the EasyShade (see **Figure 6**).
 26. Tighten the set screw in each mounting bracket until the EasyShade is secure.
 27. Uncoil the vinyl coated cables at each end of the EasyShade assembly. Allow the coiled cables to hang flat against the mounting surface.
 28. Insert the cables through the cable guide holes at each end of solar screen fabric panel (see **Figure 3**).
 29. Place the lower end of one cable through the hole in the cable guide bracket, and from the bottom, slide a cable guide stop onto the cable and secure it in place using 5/64" Allen wrench. Repeat for the other side (see **Figure 3**).
 30. Ensure the cables are tight. Adjust tension using 7/16" open-end wrench as follows. On each cable guide stop, tighten the cable by turning the 7/16" nut counter clockwise.
- NOTE: DO NOT OVER TIGHTEN THE CABLES.**
31. Test for proper operation. Enjoy.

APPENDIX A

Figure 22

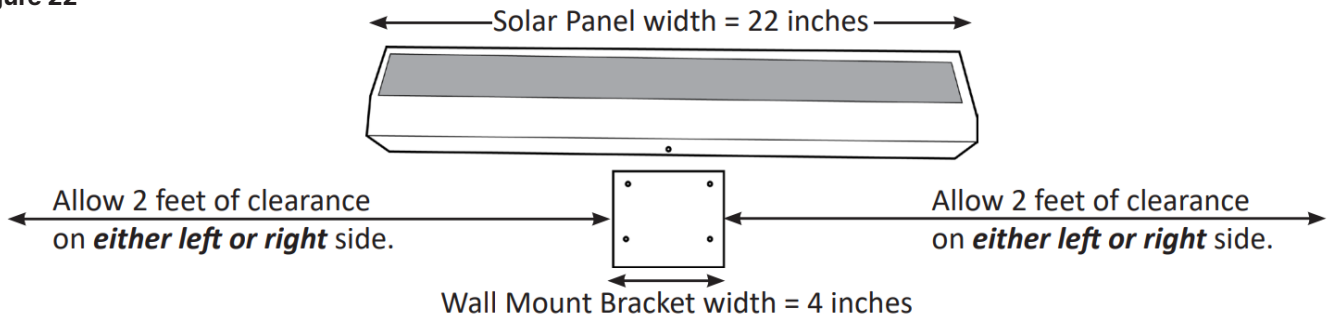

INSTALLATION OF SOLAR PANEL TO WALL MOUNT BRACKET

1. Center the solar panel in front of the mounting bracket.
2. Set the bottom of the solar panel against the house, so Allen set screw (see **Figure 23**) points up toward the bottom of the mounting bracket.

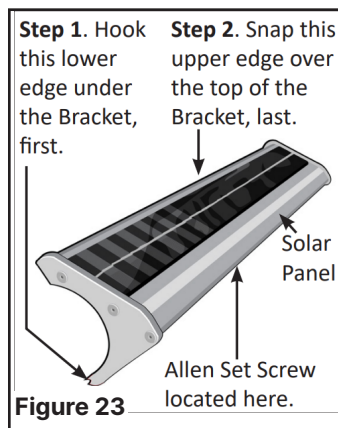

3. Hook the lower edge of the panel under the lower edge of the mounting bracket (See step 1 in **Figure 23**).
4. Press the top of the solar panel over the top of the mounting bracket, so the top lip of the panel snaps onto the top groove of the bracket (see step 2 in **Figure 23**).
5. Tighten the Allen set screw, under the solar panel, ensuring the solar panel is secured to the bracket and will not slide either left or right.

REMOVAL OF SOLAR PANEL FROM WALL MOUNT BRACKET

1. Disconnect the power cord between the solar panel and the EasyShade motor.
2. Loosen the Allen set screw (see **Figure 23**) under the solar panel.
3. Carefully slide the solar panel to the left or right side, until it separates from the bracket.

CAUTION: If the solar panel does not easily slide off the Wall Mount Bracket, nudge it gently. Do not use a hammer to bang the solar panel assembly, as permanent damage may occur.

⚠ WARNING: WHEN USING A LADDER OR ANY OTHER CLIMBING DEVICE, YOU MUST USE EXTRA CAUTION WHEN SLIDING THE PANEL OFF THE BRACKET.

WE RECOMMEND TO POSITION THE CLIMBING DEVICE TO THE SIDE TOWARD WHICH YOU WILL BE REMOVING THE PANEL. IT IS HIGHLY RECOMMENDED TO HAVE A HELPER SECURE THE CLIMBING DEVICE. FAILURE TO DO SO COULD RESULT IN A FALL AND IN PERSONAL INJURY!