

**OWNER'S MANUAL  
& INSTALLATION  
INSTRUCTIONS**

*Do Not Discard,  
Retain for Future Reference*

**Solar  
Powered  
EasyShade<sup>®</sup>**

**WARNING:  
FAILURE TO FOLLOW THESE  
INSTRUCTIONS COULD RESULT  
IN PERSONAL INJURY!**

# Solar Powered Motorized EasyShade® Owner's Manual & Installation Instruction

## Solar Powered Motorized EasyShade Schematic View

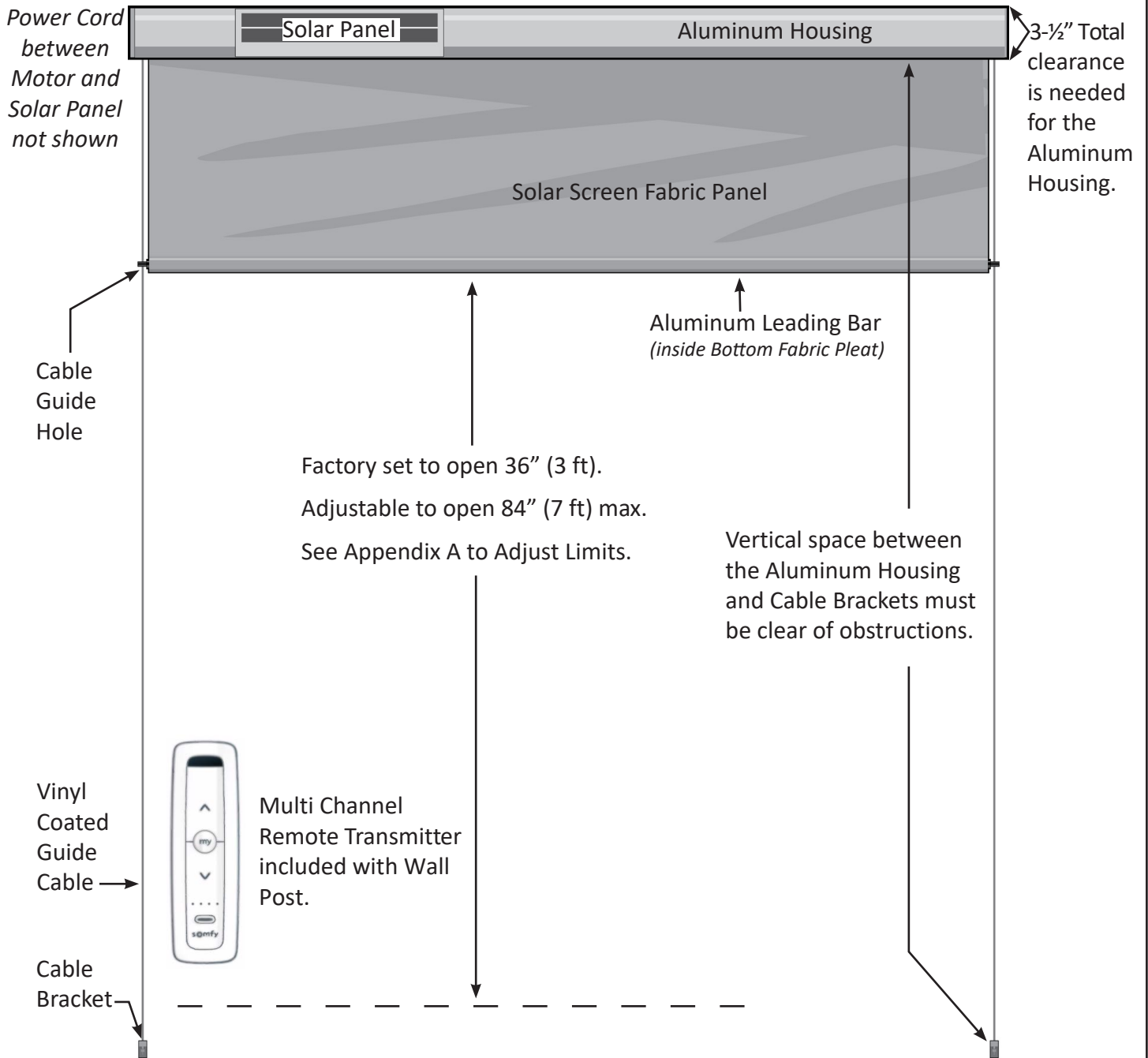

**Note:** The Solar Screen Fabric Panel width is 3" less than the EasyShade width (measured at the Aluminum Housing).

Figure 1

# READ ME FIRST

## Congratulations

You have just purchased a Solar Powered EasyShade. The EasyShade saves you energy by stopping the glare and the heat before it can enter your home, yet still lets you enjoy your view, all at the touch of a button.

## Customer Support

Our technical experts are available via email [contactus@sunsetter.com](mailto:contactus@sunsetter.com) or call us at **800-670-7071** should you require assistance. We also invite you to visit the Owner's Corner at <http://ownerscorner.sunsetter.com> for additional information on your Motorized EasyShade. You may need to register your purchase by calling **800-670-7071**. Please be prepared to provide the size (width) of the EasyShade, Motor side (left or right), color of Housing, color of Fabric Panel, and Date of Purchase.

## Factory Limit Settings

The **Up and Down stop limits** on the EasyShade motor were set at the factory to stop 36" from the Housing. This will allow for completion of the installation process, where you will be instructed to adjust the Down Position Limit to a maximum 84".

## Remote Transmitter

EasyShades are programmed to **operate on Channel 1** of the specific Remote Transmitter provided with the EasyShade. The EasyShade can be operated on any individual channel or multiple channels, and more than one EasyShade can be operated on the same channel. See **Appendix C** for Programming Instructions for the Multi-Channel Remote Transmitter.

# TABLE OF CONTENTS

<b>Motorized EasyShade Schematic View</b> . . . . .	<b>Inside Front Cover</b>
<b>Tools Needed</b> . . . . .	<b>2</b>
<b>Parts Supplied</b> . . . . .	<b>2</b>
<b>Pre-Installation Note</b> . . . . .	<b>2</b>
<b>Installation</b> . . . . .	<b>3</b>
<b>Vertical Mounting</b> . . . . .	<b>3</b>
<b>Horizontal Mounting</b> . . . . .	<b>4</b>
<b>Operating the EasyShade</b> . . . . .	<b>7</b>
<b>Remote Transmitters are Unique</b> . . . . .	<b>7</b>
<b>FAQs - Frequently Asked Questions</b> . . . . .	<b>8</b>
<b>Troubleshooting - Installation</b> . . . . .	<b>9</b>
<b>Troubleshooting - Appearance</b> . . . . .	<b>10</b>
<b>Troubleshooting - Operation</b> . . . . .	<b>10</b>
<b>Troubleshooting - Operation (Additional Motor Troubleshooting)</b> . . . . .	<b>12</b>
<b>Appendix A - Adjusting the Up and Down Position Limits of the EasyShade Motor</b> . . . . .	<b>13</b>
<b>Appendix B - Programming the Motor and Remote Transmitter</b> . . . . .	<b>14</b>
<b>Appendix C - Programming Instructions - Multi-Channel Remote Transmitter</b> . . . . .	<b>15</b>
<b>5-Year Limited Manufacturer's Warranty</b> . . . . .	<b>16</b>

**\*Helper Needed\***

**Tools Needed:** Electric Drill, 1/8" Drill Bit, Pencil, 7/16" Open End Wrench, Phillips Screwdriver, Tape Measure, Ladder, and Level.

**Parts Supplied:** Solar Motorized EasyShade Assembly (not shown below), Solar Panel with Internal Battery, Mounting Brackets, #8 x 1- 1/2" Round-Head Screws, 1/8" Allen Wrench (for the Mounting Bracket Set Screws), Two (2) Cable Guides, Two (2) Cable Guide Brackets, Two (2) Cable Guide Stops , 5/64" Allen Wrench (for Cable Guide Stop Set Screws), #8 x 1- 1/2" Flat-Head Screws, One (1) 4mm Allen Wrench and Allen set screw (for the Solar Panel Housing) and One (1) Multi-Channel Remote Transmitter with Wall Mounting Kit

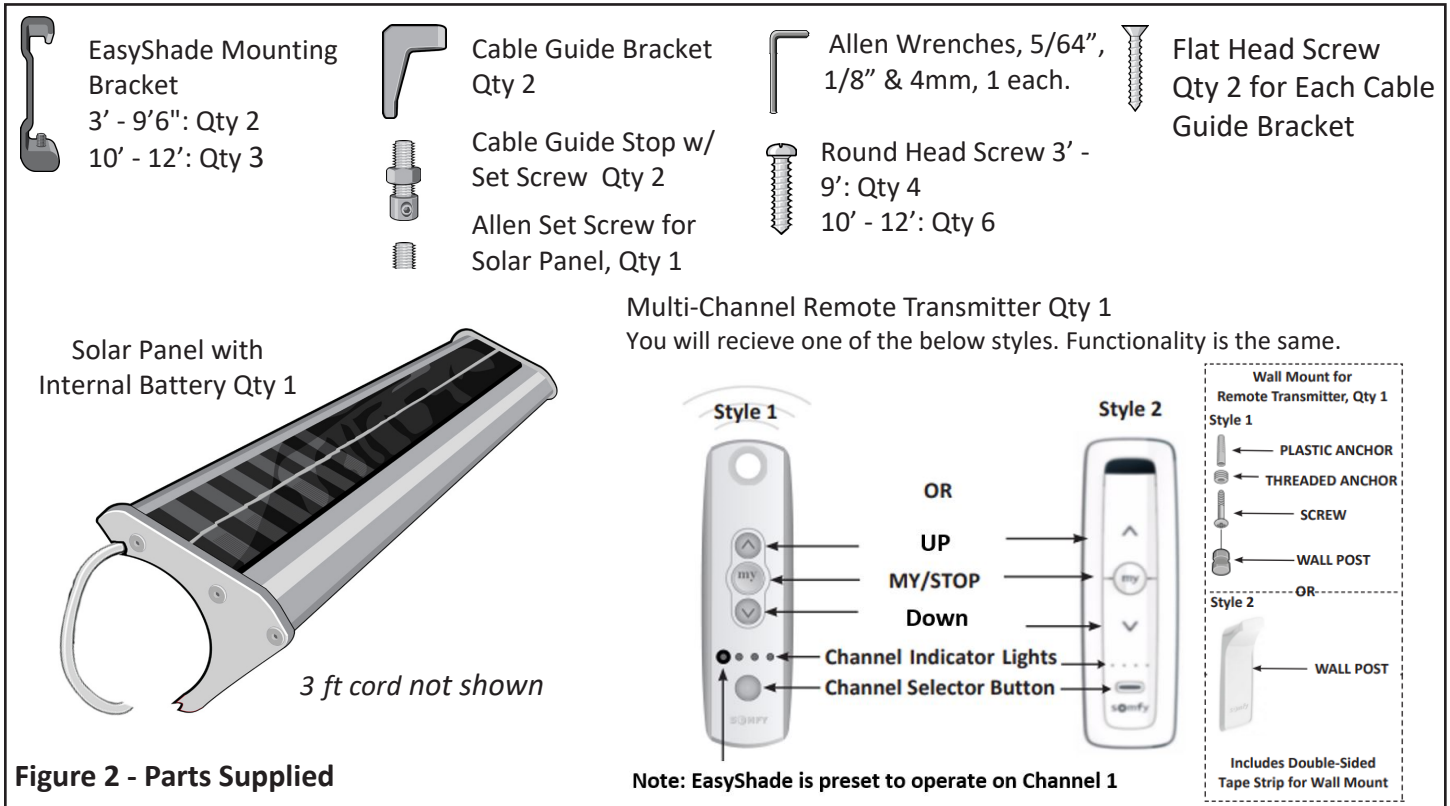

**WARNING: FAILURE TO FOLLOW THESE INSTRUCTIONS CAN RESULT IN PERSONAL INJURY! PLEASE READ THESE INSTRUCTIONS IN ITS ENTIRETY BEFORE ATTEMPTING TO COMPLETE THIS INSTALLATION.**

**PRE-INSTALLATION NOTE**

**Note:** Prior to installing your Solar Powered Motorized EasyShade, please review Figure 1 (Solar Powered Motorized EasyShade Schematic View) then inspect to ensure that there are no obstructions on your wall surface, such as light fixtures or door handles that would interfere with or block the Fabric Panel as it is extended. For proper operation you must ensure that the Aluminum Housing and Cable Guide Brackets are mounted on the same vertical plane or surface.

The Solar Powered Motorized EasyShade can be installed with the Mounting Brackets on a wall (Vertical Surface, see Figure 4) or on the underside of a structure (Horizontal Surface, see Figure 5). Each of the Brackets should be installed no more than 10" from the end of the Aluminum Housing. For the 10' to 12' models, the third Mounting Bracket should be installed at the mid point between the two End Brackets.

The Aluminum Housing requires 3-1/2" of clear, unobstructed space along the mounting surface of the wall or underside of the structure/soffit.

Vertical space between the Aluminum housing and the lower location of the Cable Guide Bracket must be clear of obstructions to allow the Fabric Panel to freely extend.



# INSTALLATION

## SOLAR PANEL AND BATTERY

It is recommended the Solar Panel be placed in the sun during the installation process to begin the Battery recharging process.

Your Solar Powered Motorized EasyShade can be used right away.

If you are not installing right away, place the Solar Panel in the sun for a day to fully charge the Battery.

## ATTACH SOLAR PANEL TO EASYSHADE® HOUSING

The Solar Panel with Battery must be attached to the Motorized EasyShade Housing before the EasyShade is mounted into the Brackets. See **Figure 3**.

**1.** Connect the Power Cord between the Motor and the Solar Panel. The Connectors are Keyed to ensure proper alignment of Pins in the Cable Connectors. Secure the ends together using the Screw Locking Mechanism on the Connectors. See **Figure 3**.

**2.** Attach the Solar Panel to the Easy Shade Housing.

**Note:** When positioning the Solar Panel on the Housing, route the Power Cable that is connected to the Motor behind the housing. Move the Solar Panel far enough away to remove slack in the Power Cable. Total length of the combined Cable is about four feet. For narrow EasyShades, excess Cable can be tucked behind the Housing.

**2a.** The bottom edge of the Solar Panel hooks under the front of the Fabric Panel Opening of the EasyShade Housing. See **Figure 3**.

**2b.** The top of the Solar Panel snaps firmly over the top front edge of the Housing. See **Figure 3**.

**3.** Use the 4mm Allen wrench (supplied) to secure the Solar Panel to the EasyShade Housing by inserting and tightening the provided Allen set screw under the bottom edge of the Solar Panel, then tighten.

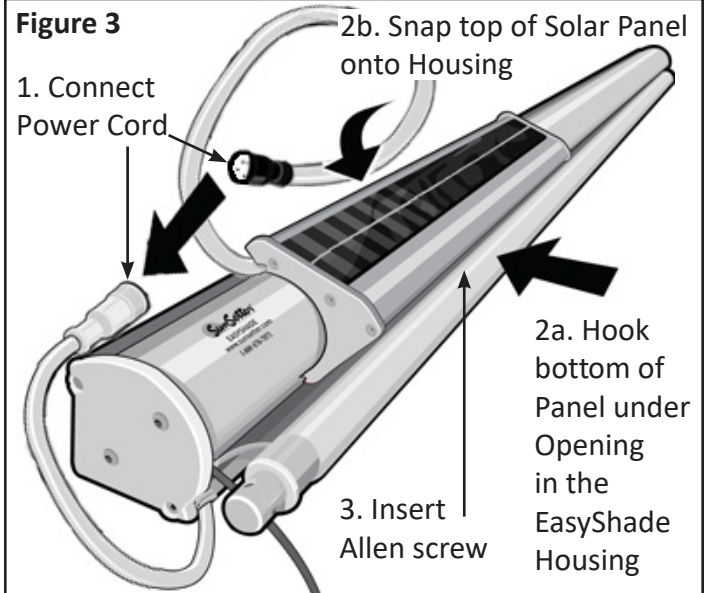

## MOUNT EASYSHADE® HOUSING TO HOUSE

**4.** Determine the desired location for the Mounting Brackets, making sure they are plumb and level. Mark the 2 hole locations with a pencil, for the Bracket. Drill holes with a 1/8" bit, approximately 1-1/2" deep, at both hole locations. Repeat for the Mounting Bracket on the other side, and the center mounting location on 10' to 12' models.

## INSTALL MOUNTING BRACKET - VERTICAL

**5.** For mounting on a wall (Vertical Surface), secure each Bracket with two #8 x 1-1/2" Round Head Screws. Note the orientation of the Bracket; the end with the Set Screw should be at the bottom. See **Figure 4**.

**Note:** Aluminum Housing and Cable Brackets need to be mounted on the same Vertical Surface. If mounted to siding, it may be necessary to shim the Brackets to create a flat mounting surface.

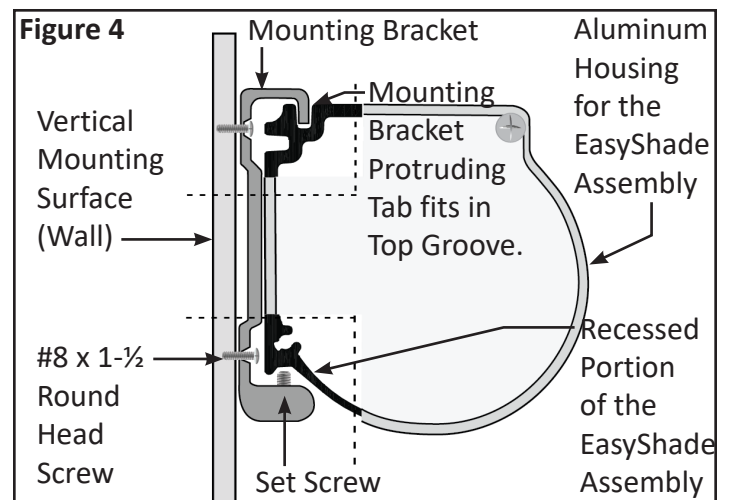

## INSTALL MOUNTING BRACKET - HORIZONTAL

6. For mounting on an underside structure (Horizontal Surface), secure each Bracket with two (2) #8 x 1-½" Round Head Screws. **Note the orientation of the Bracket;** the end with the Set Screw should face toward you as you face your Mounting Location. See **Figure 5**.

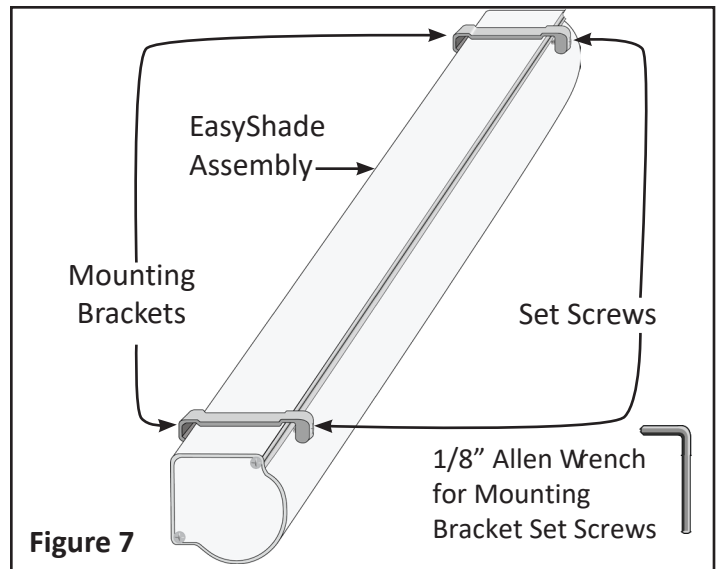
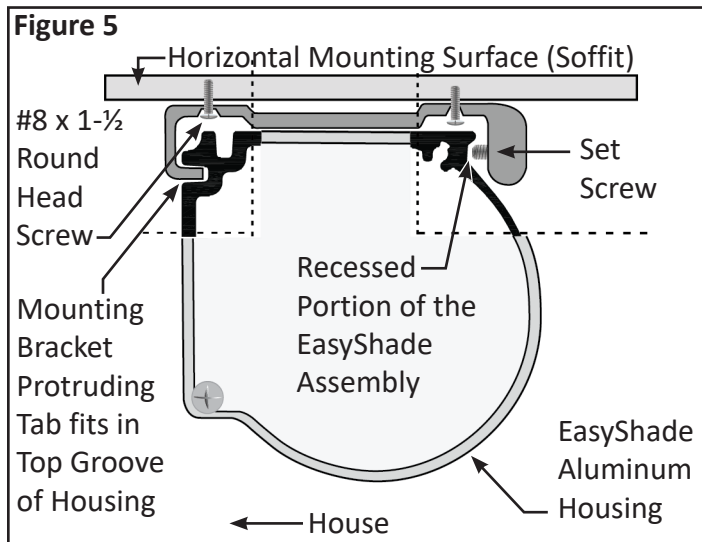

**Note: The Up and Down Stop Limits on the EasyShade Motor were set at the factory prior to shipment. The Down Stop Limit was set for a 36" extension. This will allow for completion of the installation process.**

9. Extend your EasyShade using the **DOWN** button on your Remote Transmitter (see **Figure 8**). Once you have extended the EasyShade, **unplug the Motor Power Cord from the Solar Panel Cord.**

## INSTALL EASYSHADE® INTO BRACKETS

7. With your helper, lift the EasyShade Assembly up to the installed Mounting Brackets and insert the Top Groove of the EasyShade Assembly onto the Protruding Tab of the Mounting Brackets (see **Figure 4 and 5**). While maintaining upward pressure to keep the Top Groove of the EasyShade Assembly on the Tab of the Mounting Brackets, press the EasyShade Assembly toward the Mounting Bracket and be sure the Set Screw is aligned in the Recessed Area of the EasyShade Assembly. See **Figure 6**.

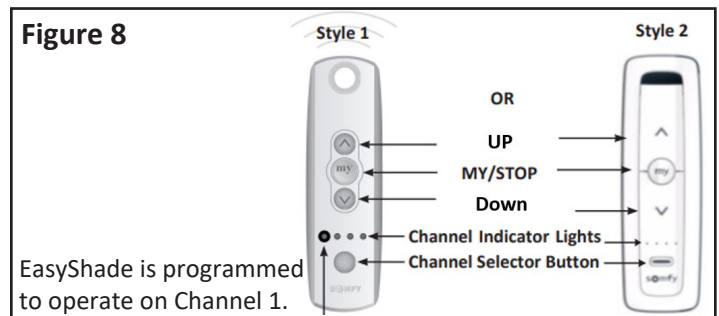
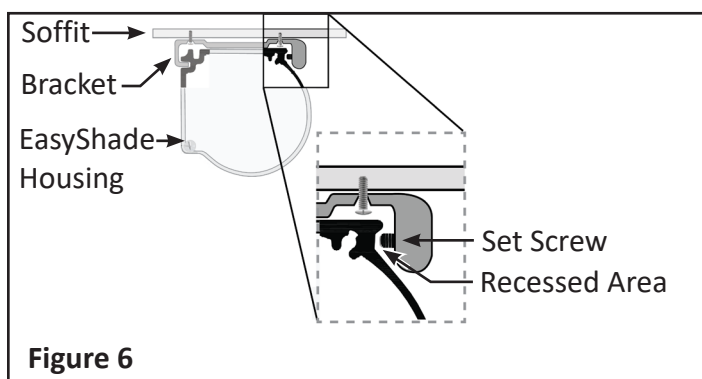

**Note:** If the EasyShade does not respond when you press the **DOWN** button on the Remote Transmitter, check to see if the first Channel Selector Light on the Remote Transmitter blinks on and off when you press the **DOWN** button (see **Figure 9**). If one of the other Channel Lights comes on, press the Channel Selector Button until you have switched to the first Channel. See **Figure 9**.

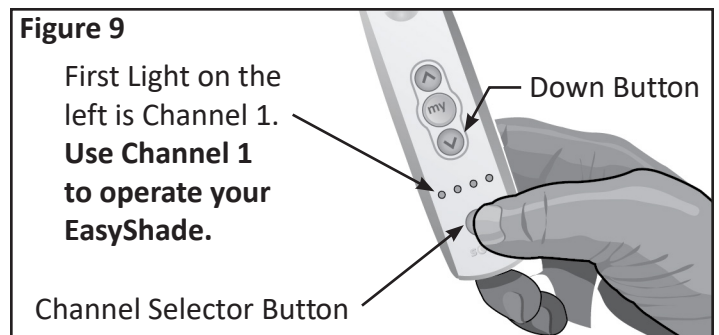

8. Using the supplied 1/8" Allen wrench, tighten the Set Screw in each Mounting Bracket until the EasyShade Assembly is secure. See **Figure 7**.

**CAUTION:** The installation procedure for the Motorized EasyShade includes the use of Cable Guides to stabilize the extended Solar Screen Fabric Panel during normal use. If your application does not permit the installation of the necessary Cable Guides or you do not plan to install them, you must use additional care to prevent damage to your product. While we do not recommend installing the Motorized EasyShade without the supplied Cable Guides, some customers may determine that their application does not have a vertical surface to install the supplied Cable Guides as instructed.

10. Unroll the Vinyl Coated Guide Cables located at each end of the Aluminum Housing Assembly, and allow them to hang flat against the Mounting Surface. See **Figure 10**.

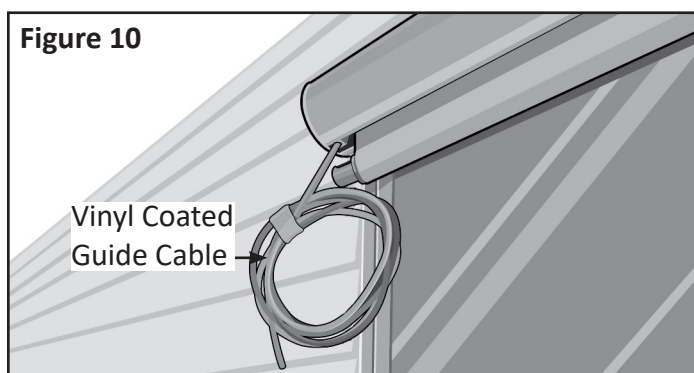

11. Insert the Vinyl Coated Guide Cable, located at each end of the Aluminum Housing Assembly, through the Guide Holes at each end of the Leading Bar at the bottom of the EasyShade Solar Screen. See **Figure 11**.

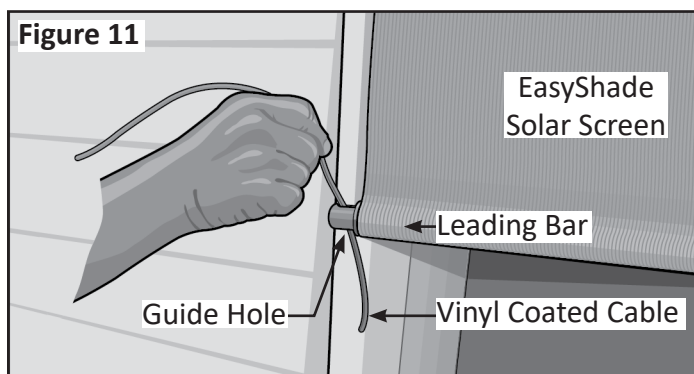

12. Determine how far down your EasyShade will be extended (this is limited to the length of the Vinyl Coated Cable, but you can not exceed 84" from the bottom of the EasyShade Housing). **Mark a Horizontal Line** on the wall below each end of the EasyShade Housing Assembly. See **Figure 12**.

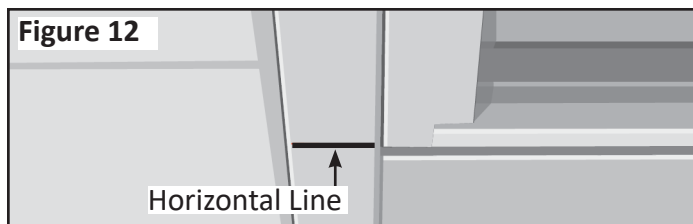

13. Using the Vinyl Coated Cable as a guide, ensure the Cable is straight and plumb (using a level) and mark a Vertical Line (see **Figure 13**) where it crosses the Horizontal Line made in **Step 12**. Cable Guide Brackets must be mounted on the same vertical plane as the EasyShade Aluminum Housing.

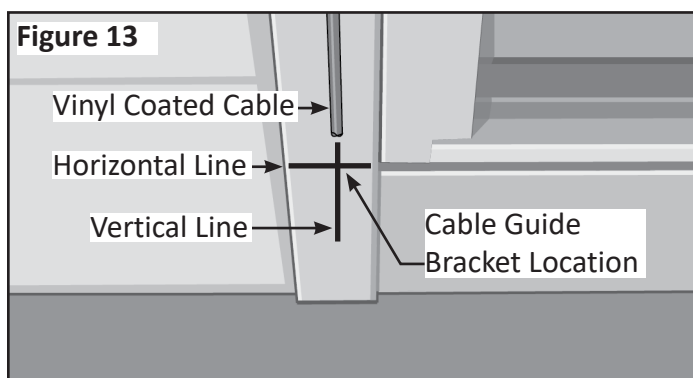

14. Locate the Cable Guide Brackets and Cable Guide Stops in your Hardware Package.

15. Align the top of the Cable Guide Brackets below the Horizontal Line and centered on the Vertical Lines as shown in **Figure 14**. Ensure the Bracket is plumb and on the same vertical plane as the Aluminum Housing above, then mark both screw hole locations. Remove the Bracket and pre-drill both screw hole locations with a 1/8" drill bit. Repeat for the other side of the EasyShade.

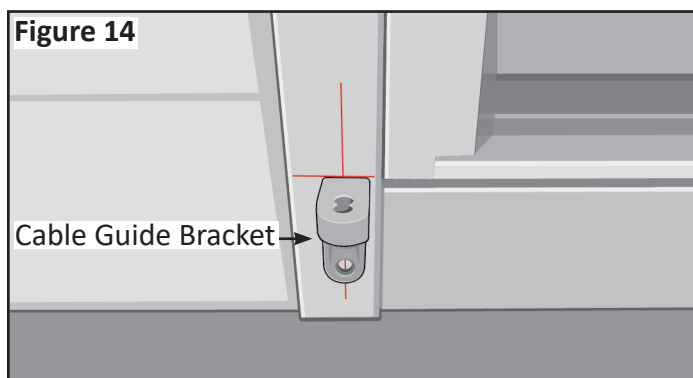

16. Place the Cable Guide Bracket over the pre-drilled holes and secure in place with the #8 x 1-1/2 Flat Head Screws.

17. Place the lower end of one of the Vinyl Coated Cables through the hole in the Cable Guide Bracket you just installed. From the bottom, slide one of the Cable Guide Stops onto the Vinyl Coated Cable and secure in place with the supplied 5/64" Allen Wrench. Repeat for the other side of the EasyShade. See Figure 15.

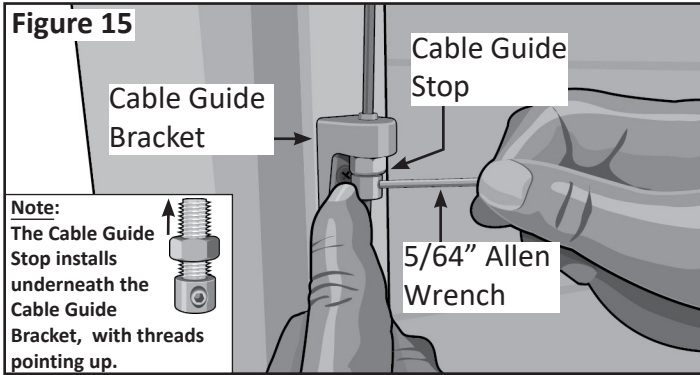

18. Ensure the Vinyl Coated Cables are tight. Adjust Cable Tension by turning the Cable Stop Nut Counter Clockwise, using a 7/16" Open End Wrench. See Figure 16.

**Note:** Do not over tighten the Cable.

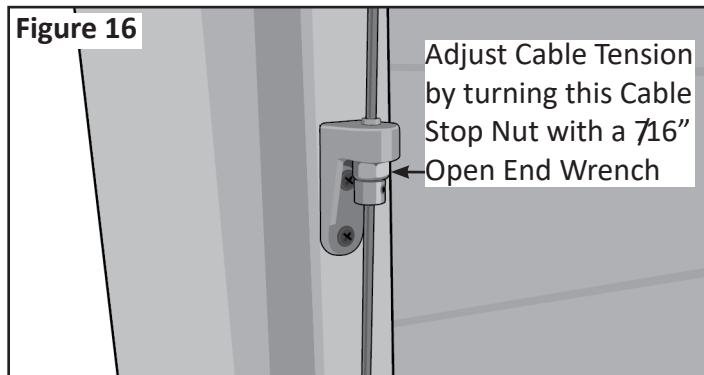

19. Trim off excess Vinyl Coated Cable extending from the bottom of the Cable Guide Stops, if desired. See Figure 17.

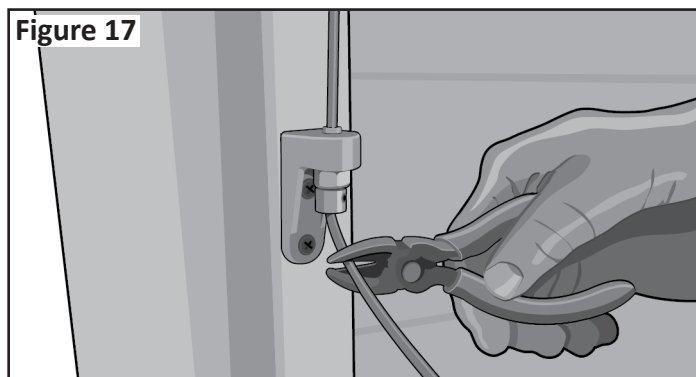

**Note:** The Solar Screen is preset to stop 36" from the Housing. This position can be changed to lower the Solar Screen as much as 84" from the Housing.

**20. Plug in the Motor.**

Press and release the UP button on your Remote Transmitter to retract the EasyShade. See Figure 18.

21. Press and release the DOWN button on your Remote Transmitter to extend the EasyShade to the current "factory setting." **Let the EasyShade stop on its own.**

See Figure 18.

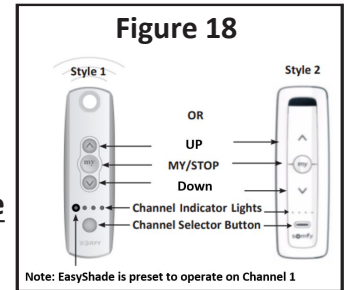

22. Press and hold the UP and DOWN buttons on the Remote Transmitter simultaneously, until the EasyShade jogs or moves, then release the buttons. See Figure 18.

**Note:** The EasyShade is temporarily in Programming Mode. The UP and DOWN buttons on the Remote Transmitter must be pressed and held to reposition the EasyShade. When either button is released, the Solar Screen will stop moving.

23. Press the DOWN or UP buttons individually to adjust the new Down stop limit to the position marked in Step 12. See Figure 12.

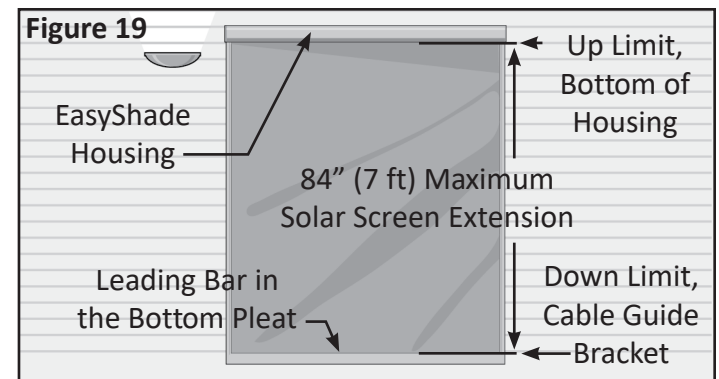

**CAUTION:** Do not let the EasyShade extend more than 84" from the Housing. See Figure 19.

24. Press and hold the STOP (my) button on the Remote Transmitter until the EasyShade jogs, then release. Your new Down limit position is set and Programming Mode ends. The UP and DOWN buttons now return to work in "one-touch" User mode.







## Operating the EasyShade®

**25.** Test the operation of your EasyShade by using the **UP**  and **DOWN**  buttons on the Remote Transmitter.

**25a.** Press and release the **UP**  button. The EasyShade will roll up into the EasyShade Housing and stop on its own. The **Up** stop limit should stop the EasyShade automatically, before the Leading Bar in the Bottom Pleat of the Solar Screen reaches the Housing.

**25b.** Press and release the **DOWN**  button. The EasyShade will unroll from the EasyShade Housing and stop on its own. The **Down** stop limit should stop the EasyShade automatically, before the Leading Bar in the Bottom Pleat of the Solar Screen reaches the physical limit of the Cable Guide Bracket. See **Appendix A** to adjust this stop limit.

**26.** A Wall Holder has been provided for the Remote Transmitter. See **Figure 2**. Position the Wall Mount in a safe location, protected from weather.

**CAUTION:** Do not leave your Motorized EasyShade extended during windy conditions, as the uncontrolled movement of the extended EasyShade Solar Screen Fabric Panel could cause damage to the product and surrounding items. Simply retract the Motorized EasyShade by pressing the **UP**  Button on the Remote Transmitter.

**CAUTION:** Do not permit the hand-held Remote Transmitter to get wet as this can affect its proper operation. It is recommended to keep the Remote Transmitter indoors when the EasyShade is not in use or if rain is expected.

**CAUTION:** The installation procedure for the Motorized EasyShade includes the use of Cable Guides to stabilize the extended Solar Screen Fabric Panel during normal use. If your application does not permit the installation of the necessary Cable Guides or you do not plan to install them, you must use additional care to prevent damage to your product. While we do not recommend installing the Motorized EasyShade without the supplied Cable Guides, some customers may determine that their application does not have a vertical surface to install the supplied Cable Guides as instructed.

“Congratulations, your installation is complete.”

## Remote Transmitters are Unique

Each Remote Transmitter and each Channel of each Remote Transmitter (see **Figure 20**) has its own unique ID code. Each Motorized EasyShade is programmed to receive a signal from a unique Remote Transmitter. A Remote Transmitter can only communicate with a Motor if the Motor has been specifically programmed to accept signals from that specific Remote Transmitter.

Each Motorized EasyShade is packaged with a Remote Transmitter programmed to control that specific EasyShade. It is recommended to use **Channel 1** (see **Figure 20**), the first light from the left, to control the Motorized EasyShade.

If you own more than one Motorized EasyShade, keep the Remote Transmitter with the EasyShade for which it was programmed.

To control multiple EasyShades with one or more Remote Transmitters or Channels, see **Appendix C**.

**Figure 20**

Each light represents a separate Channel with its own unique ID, which operates as a unique Remote Transmitter. Use **Channel 1** to operate your EasyShade.  **Channel 1** is the first light on the left.



**Channel Selector Button**  
Press this button and the selected Channel blinks.  
Press this button while the selected Channel blinks, and the next Channel is selected.

## FAQ - Frequently Asked Questions

### 1: What type of Motor is used?

The Solar Powered Motorized EasyShade uses a Somfy 12v motor with a Multi-Channel Remote Transmitter.

### 2: Does the Solar Panel have to face the sun to absorb energy?

It does not have to directly face the sun. The closer the Panel faces the sun, the quicker the Battery recharges.

**Note:** For more shady areas, a remote mounting plate and six foot extension cord are available for purchase.

### 3: How much time is required to fully charge the Solar Powered Battery?

Up to one day in full sunlight.

### 4: How many times can the Solar Powered EasyShade operate on a full charge?

The Motorized EasyShade can open and close several times on a full, single charge.

### 5: Can I operate the Solar Powered EasyShade on cloudy days?

Yes, provided that the Battery has been charged by the Solar Panel.

### 6: Can I operate the Solar Powered EasyShade in the dark?

Yes, provided that the Battery has been charged by the Solar Panel.

### 7: If it's rainy and/or cloudy for 5 days will my ES operate?

Yes, provided that the battery has been charged by the Solar Panel.

### 8: Is there a battery back up?

No. The unit operates on stored battery power, not directly from the Solar panel.

### 9: Is there a manual override?

No.

### 10: Can the Solar Panel be left out in the winter?

Yes. The Solar Powered Motorized EasyShade is an outdoor product that can withstand freezing and wintry conditions. **Note:** If the Fabric gets wet, it can freeze in the Housing and fail to unroll until the Fabric thaws out.

### 11: Can the Solar Panel get wet?

Yes. The Solar Powered Motorized EasyShade is an outdoor product and can withstand rain.

### 12: Is there any special care & maintenance needed?

The Solar Panel area must be kept clear of debris in order to properly charge the Battery.

Wet Fabric should not be rolled into the Housing during freezing conditions. If the Fabric becomes frozen in the Housing, you must allow the unit to completely thaw before unrolling the Fabric.

### 13: What type of Battery is used?

Rechargeable 12 volt Nickel-Metal Hydride.

### 14: What is the expected life span of the Battery?

The Battery is **warranted for three (3) years** not to fail under normal conditions if maintained, operated, used, and stored in accordance with the instructions contained with the product.







### 15: What is the expected life span of the Solar Panel?

The Solar Panel is **warranted for three (3) years** not to fail under normal conditions if maintained, operated, used, and stored in accordance with the instructions contained with the product.

### 16: Where can I purchase a replacement Solar Panel / Battery Assembly?

Replacement Solar Panel / Battery Assemblies can be purchased through Customer Service at **800-670-7071**.



# TROUBLESHOOTING

Installation	
Problem	Solution
<p>The Solar Panel needs more sun to fully charge.</p>	<p>An optional <b>remote mounting plate</b> and <b>six foot extension cord</b> are available for purchase.</p>
<p>After installation is complete, my Motorized EasyShade will not function.</p> <p>(Remote Transmitter should be set to <b>Channel 1</b>, the first light on the left side of the Remote.)</p>	<ol style="list-style-type: none"> <li>1. Use the Remote Transmitter that came with this Motorized EasyShade. Each Remote Transmitter is uniquely different.</li> <li>2. The Remote Transmitter should be set to work on <b>Channel 1</b> (one). Press the <b>UP</b>  or <b>DOWN</b>  button on the Remote Transmitter. The first Channel Indicator Light from the left should blink. If not, move to the correct Channel by pressing the Channel Select Button. See <b>Appendix C</b> for more information.</li> <li>3. The Battery in the Solar Panel was originally shipped with enough charge to run the Motorized EasyShade. <b>Expose the Solar Panel to sun for a full day to ensure enough charge exists in the Battery to run the Solar Powered Motorized EasyShade.</b></li> <li>4. Visually inspect the Power Cord connecting the Motor to the Solar Panel for possible damage.</li> <li>5. Disconnect the Power Cord connector, between the Motor and Solar Panel. Visually inspect the connector pins, ensuring none are bent or broken. Connect the two Cord sections, ensuring the pins line up properly and the Connector screws together tightly.</li> <li>6. Listen to the motor. Press the <b>UP</b>  or <b>DOWN</b>  button on the Remote Transmitter and listen for the sound of the motor turning.             <ol style="list-style-type: none"> <li>a. If the motor turns, the problem could be mechanical with the Solar Screen. The motor may turn, but the Solar Screen may be stuck inside the Housing. Try tugging on the Leading Bar in the bottom Pleat of the Solar Screen, see if it unrolls from inside of the EasyShade Housing.</li> <li>b. If the motor does not turn, the problem could be related to the Remote Transmitter. Go to <b>Step 7</b>.</li> </ol> </li> <li>7. Perform self test on the Remote Transmitter:             <ol style="list-style-type: none"> <li>a. Press and hold the <b>UP</b>  or <b>DOWN</b>  button for 5 to 10 seconds. If the LED light blinks for at least 5 seconds, the Remote Transmitter passes Self-Test.</li> <li>b. If the LED does not blink, remove and replace the battery. To replace the battery, see the battery replacement instructions under Operation, on <b>Page 10</b>.</li> <li>c. If the Remote Transmitter got wet, it may need to be replaced.</li> </ol> </li> <li>8. In extreme cold conditions, verify the EasyShade Solar Screen is not “frozen” inside the housing.             <ol style="list-style-type: none"> <li>a. A light tug on the Leading Bar in the bottom Pleat of the Solar Screen may overcome slight freezing conditions.</li> </ol> </li> </ol>

<b>Appearance</b>	
<b>Problem</b>	<b>Solution</b>
Fabric rolls up unevenly or pulls to one side when the Motorized EasyShade is being closed.	<ol style="list-style-type: none"> <li>1. Check the Aluminum Housing to ensure it is mounted level on the mounting surface.</li> <li>2. It is necessary to have the Guiding Cables completely plumb, up and down. Both the Aluminum Housing and the Cable Brackets must be installed on the same vertical surface or plane, in order for the Fabric to open and close smoothly and evenly. Please check to ensure the Guiding Cable is plumb front to back and left to right. You might need to move the Cable Brackets, or shim them, to ensure they are on the same vertical plane.</li> </ol>
Short lines appear in the Solar Screen fabric.	Very slight lines in the fabric might be noticed near the top of the Solar Screen. These are caused by clips required to secure the Solar Screen fabric to the internal roller bar. This is normal and should diminish over time, under warm conditions. This might be more pronounced under cool conditions.

<b>Operation</b>	
<b>Problem</b>	<b>Solution</b>
Remote Transmitter fails to Open or Close the EasyShade.  (Remote Transmitter should be set to <b>Channel 1</b> , see <b>Figure 25</b> )	<ol style="list-style-type: none"> <li>1. Test the Remote Transmitter for proper operation; press each button on the front of the Remote Transmitter, holding for 5 to 10 seconds. The LED light should blink for at least 5 seconds. If this fails, replace the Remote Transmitter's Battery (See <b>Figure 2</b>: Style 1 uses a <b>Lithium CR2430</b>; Style 2 uses a <b>Lithium CR2032</b>)</li> <li>2. Solar Panel Battery might not have enough charge to run the Motor. Ensure the Solar Panel has one day in the sun to recharge the Battery.</li> </ol>
Delayed response (half second) to UP or DOWN command.	The Solar Panel's Battery charge is low. Exposure to sun will recharge the Solar Panel's Battery.
Must press DOWN button three times before EasyShade responds.	The Solar Panel's Battery charge is low. Exposure to sun will recharge the Solar Panel's Battery.
EasyShade opens 1 inch, then stops.	The Solar Panel's Battery charge is low. Exposure to sun will recharge the Solar Panel's Battery.
Motor will not respond to any command.	The Solar Panel's Battery charge might be low, causing Motor to enter "sleep" mode. Exposure to sun for a full day will recharge the Battery.
The red light on the Remote Transmitter does not come on when I press the button.  <b>How to Replace Remote Transmitter's Battery.</b>	<ol style="list-style-type: none"> <li>1. <b>Remove and replace the Remote Transmitter's Battery</b> (See <b>Figure 2</b>: Style 1 uses a <b>Lithium CR2430</b>; Style 2 uses a <b>Lithium CR2032</b>). <ol style="list-style-type: none"> <li>a. Remove the small Phillips screw on the back of the Remote Transmitter,</li> <li>b. Remove back cover,</li> <li>c. Replace the old battery (be sure to note the battery orientation),</li> <li>d. Reinstall the cover with the Phillips screw.</li> </ol> </li> <li>2. If the Remote Transmitter got wet, <ol style="list-style-type: none"> <li>a. Remove the back cover to allow it to dry out completely,</li> <li>b. Once completely dry, replace the back cover and try again.</li> </ol> </li> </ol> <p><b>Note: An All Weather Remote Transmitter is available for purchase.</b></p>



<b>Operation (continued)</b>	
<b>Problem</b>	<b>Solution</b>
My Motorized EasyShade retracts but will not fully close into the Aluminum Housing.	Adjust the Up Limit on your EasyShade motor. See <b>Appendix A</b> , Adjusting the Up and Down Position Limits of the Motor.  If the Solar Screen has been replaced, new Up and Down Position Limits might need to be set for the Motor. If so, see <b>Appendix B</b> , Programming the EasyShade’s Stop Position Settings.
Fabric is stuck inside the Aluminum Housing	In extreme cold conditions, verify the EasyShade Solar Screen is not “frozen” inside the housing.  A light tug on the Leading Bar in the bottom Pleat of the Solar Screen can overcome slight freezing conditions.
My Motorized EasyShade rolls out and keeps going and the Solar Screen begins to sag.	If the Motor stops on its own at a programmed Stop Position, then adjust the Down position stop limit according to instructions in <b>Appendix A</b> .  If the Motor will not stop on its own and you must press the “my” button to stop the motor, then set new Up and Down Stop Position Limits according to instructions in <b>Appendix B</b> .
Can I program multiple Motorized EasyShades to operate on one master Remote Transmitter?	Yes. Each channel on the Remote Transmitter can control one or more Motorized EasyShades.  See <b>Appendix C</b> , Programming Instructions for Multi-Channel Remote Transmitter.
Can I use more than one Remote Transmitter to control one Motorized EasyShade?	Yes.  The Motorized EasyShade can be programmed to respond to multiple Remote Transmitters.  Additional Remote Transmitters can be purchased through Customer Service at <b>800-670-7071</b> .  See <b>Appendix B</b> , “Add/Delete A Remote Transmitter,” <b>Appendix C</b> , or follow the instructions that come with additional Remote Transmitters.
What if I lose my Remote Transmitter or it becomes damaged?  Can the original Remote Transmitter be replaced?  Do I need to reprogram my motor?	The original Remote Transmitter shipped with your Motorized EasyShade can be easily replaced. Please call Customer Service at <b>800-670-7071</b> to purchase a replacement.  The Programmed Up and Down Stop Limits are permanently stored in the Motor. These settings do not need to be reset or changed due the addition or removal of Remote Transmitters.  Instructions for replacing the Remote Transmitter are included with the replacement Remote Transmitter.
The Motorized EasyShade only operates while the <b>UP</b>  or <b>DOWN</b>  button is being pressed.	The Motor is in probably in Programming Mode. Complete the Programming procedure by following these steps:  1. Unplug the Motor, for 2 seconds, then plug it back in. 2. Press and Hold the UP and DOWN buttons until the Motor jogs. 3. Press and Hold the PROGRAMMING button (inside the small opening on the rear of the Remote Transmitter) until the Motor jogs. 4. Test operation by pressing and releasing the UP or DOWN button.  If the problem persists, please call Customer Service for assistance at <b>800-670-7071</b> .

## TROUBLESHOOTING - Additional Motor Troubleshooting

Problem with Motor	Solution
<p>Awning / Motor Does Not Respond to Remote Transmitter (First, verify that electric power is good and Remote Transmitter passes Self Test as described in the section below)</p> <p><b>or</b></p> <p>Awning / Motor only runs while holding down the UP or DOWN button on the Remote</p> <p><b>or</b></p> <p>Appendix B failed to complete properly.</p>	<ol style="list-style-type: none"> <li>1. Unplug Motor,</li> <li>2. Wait two seconds,</li> <li>3. Plug in Motor,</li> <li>4. If Motor jogs, go to <b>GROUP A</b>,</li> <li>5. If Motor does not jog, go to <b>GROUP B</b>.</li> </ol>
	<p><b>GROUP A</b></p> <ol style="list-style-type: none"> <li>1. Press and Hold the <b>CLOSE</b> and <b>OPEN</b> buttons together, on the Remote Transmitter.</li> <li>2. Hold until Motor jogs or moves.</li> <li>3. Press and Hold the <b>PROGRAMMING</b> button.</li> <li>4. Hold until Motor jogs or moves a little bit.</li> <li>5. Test for normal operation.</li> </ol>
	<p><b>GROUP B</b></p> <ol style="list-style-type: none"> <li>1. Press and Hold the <b>CLOSE</b> and <b>OPEN</b> buttons together, on the Remote Transmitter.</li> <li>2. Hold until Motor jogs or moves.</li> <li>3. Perform <b>Steps 9 - 18</b> in <b>Appendix B</b>.</li> <li>4. Test for normal operation.</li> </ol>
	<p><b>If GROUP A or B (above) does not fix the problem, then . . .</b></p> <p>Perform <b>Steps 1 - 18</b> in <b>Appendix B</b>, or call Technical Support at <b>800-670-7071</b>.</p>
<p>How to Self Test the Remote Transmitter</p>	<ol style="list-style-type: none"> <li>1. Press each button (<b>CLOSE, OPEN, my</b>) on the front of the Remote Transmitter, one at a time.</li> <li>2. Hold each button for 5 to 10 seconds.</li> <li>3. LED light should blink for at least 5 seconds, then stop blinking.</li> <li>4. If Steps 1 - 3 work, the Remote Transmitter is good.</li> <li>5. If this fails, replace the Remote Transmitter's Battery.</li> </ol>

## APPENDIX A



### Adjusting the Up and Down Stop Position for the Motorized EasyShade®

Follow these instructions to change the position where the EasyShade stops. This is for both the Up and the Down stop positions. See Figure 21.

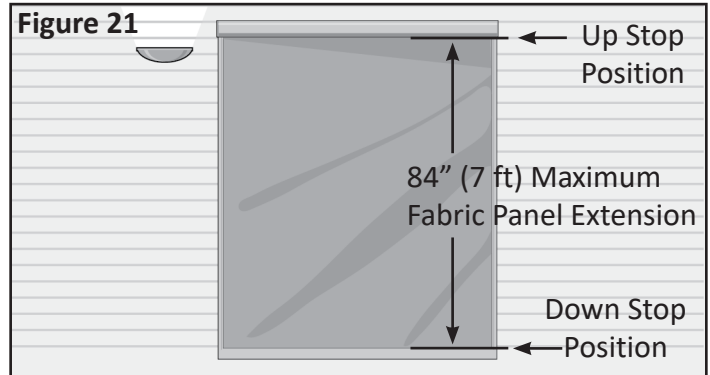

**Note:** Do Not exceed the 84" Down Stop Position Limit as this will cause the Fabric Panel to roll up backwards in the housing. See Figure 21.



#### To Change the Up Stop Position:

1. Move the EasyShade to its current Up (see **Figure 22**) position and **let it stop on its own**.
2. Press and hold the (UP)  and (DOWN)  buttons (see **Figure 24**) simultaneously until the EasyShade jogs or moves, then release.
3. Adjust to a new Up stop position.
4. Press and hold the (MY)  button until the EasyShade jogs or moves, then release.
5. Check the new Up position.

#### To Change the Down Stop Position:

1. Move the EasyShade to its current Down (see **Figure 23**) position and **let it stop on its own**.
2. Press and hold the (UP)  and (DOWN)  buttons (see **Figure 24**) simultaneously until the EasyShade jogs or moves, then release.
3. Adjust to a new Down stop position.
4. Press and hold the (MY)  button until the EasyShade jogs or moves, then release.
5. Check the new Down position.

**Note:** Every EasyShade is programmed to work on Channel 1 (see **Figure 25**) of the specific Remote Transmitter shipped with that Motorized EasyShade. For more information, see Page 7.

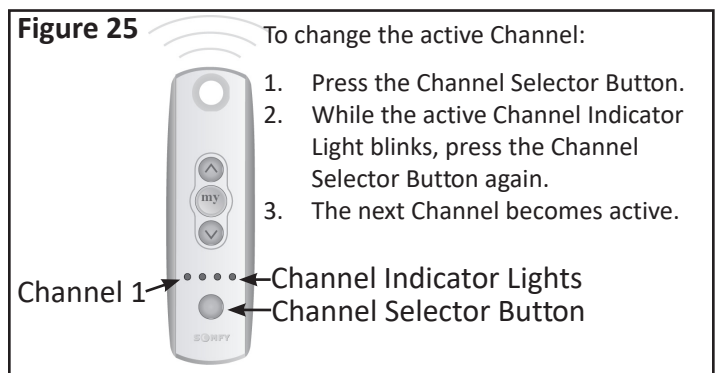
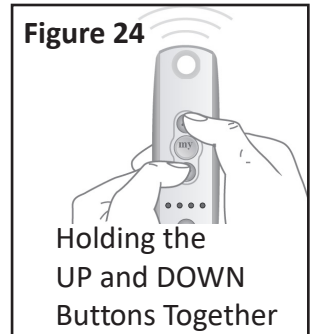
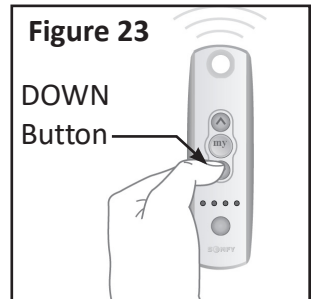
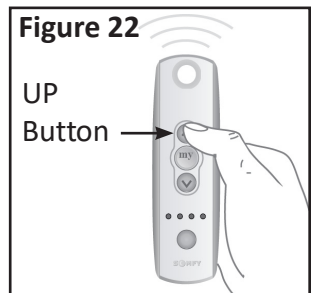

## APPENDIX B

### Programming the Motor

This procedure describes the actions needed to reset the communication between the Motor and the primary Remote Transmitter used to control your Motorized EasyShade.

This procedure programs the EasyShade Motor to accept commands from one primary Remote Transmitter. This procedure overwrites the factory set **Up** and **Down** positions with new **Up** and **Down** positions.

**Note:** To **ONLY** change the Up and Down preset positions, follow the basic procedure in Appendix A.

**Tools needed:** A pen or similar pointing device is needed to press and hold the Programming Button.

**WARNING: ALL STEPS MUST BE FOLLOWED EXACTLY AND COMPLETELY**

Front View



Figure 25

#### **PREPARE MOTOR - See Figures 25 & 26**

1. Read these instructions **FIRST**, completely and thoroughly.
2. Press and Hold the **my** button; the red LED light will blink for at least 5 seconds, then release.
3. Disconnect Power (at the Solar Panel connector) for 5 full seconds.
4. Connect Power (at the Solar Panel connector) for 10 full seconds.
5. Disconnect (at the Solar Panel connector) Power for 5 full seconds.
6. Connect Power (at the Solar Panel connector). Your EasyShade should move then stop on its own.
7. Press and hold the **Programming** button for ten seconds, watching for two separate jogs back and forth, several seconds apart.

**Note:** A single jog is a quick two-direction movement of the motor.

8. Press and Hold the **UP** and **DOWN** buttons together until your EasyShade jogs.

**Note:** The EasyShade now moves **ONLY** while holding down the **UP** or **DOWN** button.

#### **SET PROPER DIRECTION OF MOTOR ROTATION**

9. Press the **DOWN** button to check the direction of the motor.  
The Solar Screen should roll out of the Aluminum Housing, from the side closest to the house.
10. If the direction is incorrect, change direction by holding the **my** button until the motor jogs. Press the **DOWN** button again to check for the correct direction of the motor rotation.

#### **SET THE UP AND DOWN POSITIONS**

11. Move the EasyShade to the desired **UP** position.
12. Press and Hold the **my** and **DOWN** buttons together, release when the EasyShade begins to move.
13. Press the **my** button to **Stop** the EasyShade at the desired **Down** setting.
14. Make desired adjustments to the **Down** position.
15. Press and Hold the **my** and **UP** buttons together; release them when the EasyShade begins to **move Up**. **Let the EasyShade stop on its own** at the **UP** position set in step 11.
16. Press and Hold the **my** button, release when the Motor jogs. This step stores the **Up** and **Down** position limits are set.

**Note:** *If steps 8-15 fail, unplug the Power, plug back in, then begin again from step 8.*

17. Press and Hold the **Programming** button, wait for jog. This exits the Programming Mode.
18. Process complete. Test the **Up** and **Down** stop position limits.

Rear View



Figure 26

### Add/Delete a Control Device (Remote Transmitter)

To **ADD** an additional Remote Transmitter for controlling this particular EasyShade.

- Press the Programming button on the back of the Remote Transmitter that was supplied with the EasyShade until the motor “jogs.”
- On the additional Remote Transmitter, press the Programming button until the motor “jogs,” then release.

To **DELETE** a Control Device, repeat the two steps listed above; the additional Control Device is removed.

# APPENDIX C

## PROGRAMMING INSTRUCTIONS - MULTI CHANNEL REMOTE TRANSMITTER

**Note:** Each EasyShade operates on Channel 1 of the Remote that came with it.

Every Channel on every Remote Transmitter is different, but you can mix and match them.

### How to use the Multi Channel Remote Transmitter (see Figure 27):

- **To identify the currently selected Channel**, press and release the Channel Selector Button once. The currently selected Channel Indicator Light will blink.
- **To select the next Channel**, press and release the Channel Selector Button while the Channel Indicator Light blinks. The next Channel is selected and that Channel Indicator Light blinks. All 4 lights blinking means Channel 5 is selected.

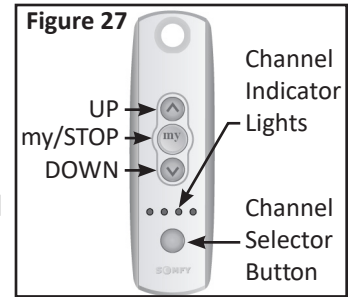

### How to program the EasyShade to work with any Channel (see Figures 28, 29 & 30):

One EasyShade can run on any Channel. See **Figure 28**.

**Add** each Channel to the EasyShade, using **STEP 1**, then **STEP 2** in **Figure 30**.



Figure 28

One Channel can run multiple EasyShades. See **Figure 29**.

**Add** that Channel to each EasyShade, using **STEP 1**, then **STEP 2** in **Figure 30**.

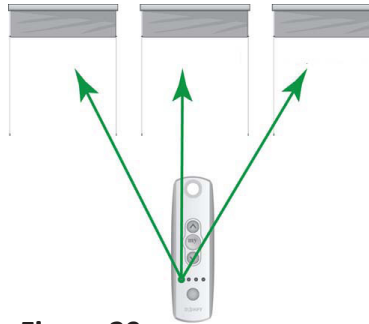
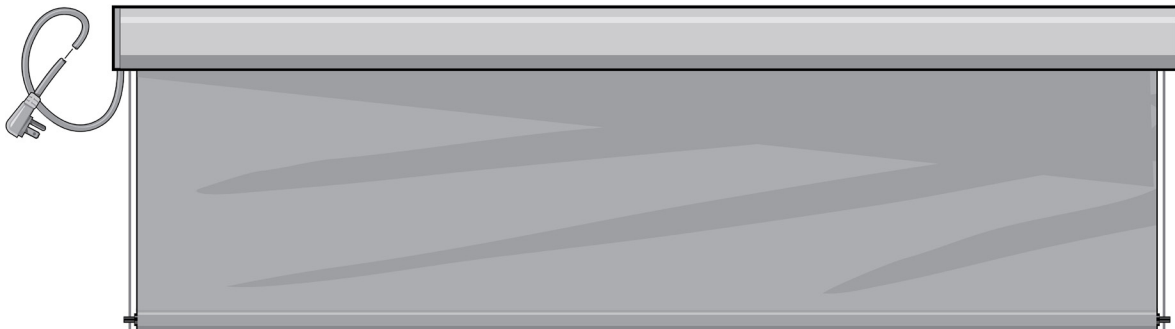

Figure 29

Unwanted Channels can be removed from an EasyShade using **STEP 1**, then **STEP 2** in **Figure 30**.

**Figure 30 Note:** It is recommended all EasyShades be unplugged from the power source except for the one EasyShade being programmed. This simplifies the process and reduces errors.



#### STEP 1

Select a Channel that **currently controls** the EasyShade being programmed.

Hold the Programming button on this remote until the EasyShade jogs or moves a little bit.



Programming button

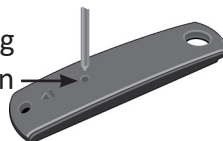

#### STEP 2

Select a Channel to **ADD** to, or **DELETE** from the EasyShade being programmed.

Hold the Programming button on this remote until the EasyShade jogs or moves a little bit.



Programming button

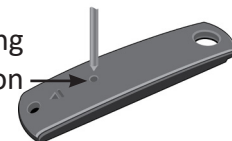

# 5-Year Limited Manufacturer's Warranty for EasyShade®

## A. WHO GIVES THIS WARRANTY?

SunSetter Products, 184 Charles Street, Malden, MA 02148.

## B. WHO IS ENTITLED TO THIS WARRANTY?

This Warranty applies only to the original purchaser who paid for the product and may not be assigned or transferred to subsequent owners. This Warranty applies only to products purchased and installed in the US.

## C. WHAT ARE THE RESPONSIBILITIES OF SUNSETTER PRODUCTS UNDER THIS WARRANTY?

Subject to the terms and conditions set forth herein, SunSetter Products will furnish replacements for parts found by SunSetter Products to be defective in design, manufacture or assembly, under each specific component or product warranty as set forth below.

## D. WHAT ARE THE RESPONSIBILITIES OF THE ORIGINAL PURCHASER UNDER THE WARRANTY?

1. Before any claims may be made under this Warranty, the original purchaser must have paid in full for the product covered under the Warranty, according to the terms and conditions of the pay-plan defined in the original order. **IF THE PURCHASER HAS FAILED TO MAKE FULL PAYMENTS ACCORDING TO THE SPECIFIC PAY PLAN FOR THE PRODUCT, THIS WARRANTY SHALL BE NULLIFIED AND SUNSETTER PRODUCTS SHALL BE RELIEVED FROM ANY RESPONSIBILITY OR LIABILITY UNDER THIS WARRANTY.** The purchaser agrees and acknowledges that this Warranty agreement constitutes an executory contract.

2. The purchaser must use care in installation, maintenance, operation, use, and storage of the product in accordance with the instructions contained with the product. **ANY FAILURE TO INSTALL,**

**MAINTAIN, OPERATE, USE AND STORE THE PRODUCT IN ACCORDANCE WITH THE INSTRUCTIONS CONTAINED WITH THE PRODUCT WILL NULLIFY THIS WARRANTY AND RELIEVE SUNSETTER PRODUCTS FROM ANY RESPONSIBILITY OR LIABILITY UNDER THIS WARRANTY.**

3. Promptly notify SunSetter Products of any claims.

4. The purchaser may be required to provide a photograph of any defective parts. The purchaser may also be required to pay a deposit until the defective parts are returned to SunSetter Products for inspection. The purchaser must obtain a return authorization form from SunSetter Products' customer service department prior to the return of any merchandise and after having received such authorization, return the part or product, freight prepaid, to SunSetter Products.

## E. WHAT IS COVERED UNDER THIS WARRANTY?

1. The following components of the EasyShade are covered under this Warranty, subject to the limitations set forth below. **These components have up to five (5) year limited (prorated) warranty,** against manufacturer's defects as outlined below:

(a) Should the purchaser promptly notify SunSetter Products of such defects within one year (12 months) from the date of the original purchase, the defective component will be replaced at no charge.

(b) After one year but within the warranty period as listed below for each component from the date of the original purchase, a defective component will be replaced upon the purchaser's payment of the prorated amount based on full retail price of the specific components and the number of months from the date of the original purchase till the claim date as percent of the total number of months during the warranty period.

*(Continued on next page.)*



## 2. Covered Components:

**STRUCTURAL COMPONENTS AND GEAR MECHANISM OR ELECTRIC MOTOR** (whichever applies to your model) are **warranted for five (5) years** not to fail under normal conditions if maintained, operated, used, and stored in accordance with the instructions contained with the product.

**VINYL MESH** is **warranted for five (5) years** against:

(a) Excessive fading under normal conditions if maintained, operated, used, and stored in accordance with the instructions contained with the product.

(b) Mildew on vinyl mesh. Mildew will not form on the mesh itself, but may form on dirt and dust that have not been removed from it. The purchaser must clean the vinyl mesh periodically with water and mild soap to prevent dirt from accumulating.

(c) Excessive cracking or peeling under normal conditions if maintained, operated, used, and stored in accordance with the instructions contained with the product.

**SOLAR PANEL ASSEMBLY (solar-powered model)** is **warranted for three (3) years** not to fail under normal conditions if maintained, operated, used, and stored in accordance with the instructions contained with the product.

**BATTERY PACK (solar-powered model)** is **warranted for three (3) years** not to fail under normal conditions if maintained, operated, used, and stored in accordance with the instructions contained with the product.

## F. WHAT IS NOT COVERED UNDER THIS WARRANTY?

1. Any failure or damage of the components that results from any intentional or negligent actions by the purchaser or by any other person is not covered by this Warranty.

2. It is the responsibility of the purchaser to securely fasten the EasyShade to studs, joists, headers or other structural members. Any failure or damage that results from the EasyShade falling from its installed position is not covered by this Warranty.

3. Labor charges connected with installation of replacement parts are not covered by this Warranty.

4. Freight expenses for shipping damaged or replacement parts are not covered by this Warranty and must be paid by the purchaser.

## G. GENERAL PROVISIONS AND LIMITATIONS

1. THE WARRANTY GRANTED HEREIN IS THE EXCLUSIVE REMEDY FOR THE PURCHASER. SUNSETTER PRODUCTS MAKES NO OTHER WARRANTIES TO THE PURCHASER, EXPRESS, STATUTORY, IMPLIED OR OTHERWISE AND ALL IMPLIED WARRANTIES, INCLUDING WITHOUT LIMITATIONS, IMPLIED WARRANTIES OF MERCHANTABILITY AND FITNESS FOR A PARTICULAR PURPOSE, ARE HEREBY DISCLAIMED.

2. TO THE EXTENT PERMITTED BY LAW, SUNSETTER PRODUCTS SHALL HAVE NO LIABILITY TO THE PURCHASER OR ANY OTHER PERSON FOR INCIDENTAL, SPECIAL, CONSEQUENTIAL, INDIRECT OR SIMILAR DAMAGES OF ANY KIND OR NATURE WHATSOEVER, WHETHER ARISING OUT OF BREACH OF WARRANTY OR OTHER BREACH OF CONTRACT, NEGLIGENCE OR OTHER TORT, OR OTHERWISE, EVEN IF SUNSETTER PRODUCTS SHALL HAVE BEEN ADVISED OF THE POSSIBILITY OR LIKELIHOOD OF SUCH POTENTIAL LOSS OR DAMAGE. IN NO EVENT SHALL SUNSETTER PRODUCTS BE LIABLE FOR LOSS OF PROFITS AND/OR WAGES.

3. Some states do not allow limitations on how long an implied warranty lasts, or do not allow the exclusion or limitation of incidental or consequential damages, so the above limitations may not apply to you.

4. This warranty gives you specific rights, and you may have other rights, which vary from state to state.

**A place for your notes:**