



For Technical Support visit us at ownerscorner.sunsetter.com
or Call Toll Free 800-670-7071 • Fax 877-224-4944

OASIS Roller Cap Square Pin Replacement Instructions

Helpers Needed

Tools Needed: Hammer, Locking Pliers, $\frac{1}{16}$ " Socket and Driver, $\frac{1}{16}$ " Wrench, Saw Horses, Step Ladder

Parts Supplied: Roller Cap Square Pin, Four (4) Plastic Safety Sleeves

WARNING: FAILURE TO FOLLOW THESE INSTRUCTIONS CAN RESULT IN PERSONAL INJURY!! PLEASE READ THESE INSTRUCTIONS COMPLETELY BEFORE ATTEMPTING THIS PROCEDURE.

1. Open the Awning to the fully opened position.

2. On the end of the OASIS Awning opposite the Gear Assembly, locate the Front Bar Connectors that secure the Lateral Arms to the Front Bars and using a 5mm Allen wrench; loosen the **Inside Bolt ONLY** on the Front Bar Connector on both of the Front Bars on that end of the Awning. See Figure 1.

NOTE: If you can close your OASIS Awning using the Crank Wand, continue with Step 7.

If you cannot close your Awning using the Crank Wand, complete the following procedure (Steps 3 through 6) and then continue with Step 7.

WARNING: MAKE SURE THAT NO ONE STANDS IN FRONT OF THE AWNING DURING THIS PROCEDURE, IN CASE THE AWNING SPRINGS OPEN.

3. Position a step ladder at the Gear Assembly end of the Awning (Note: outside the Awning, not under the Awning) and align with the elbow of the Left Arm Assembly. See Figure 2.

4. Starting with the Left Arm Assembly, push in on the Lateral Arm Elbow to start the Arm to close and grasp the outside edge of the Front Bar and pull it in toward the End bracket.

5. Continue to pull the Front Bar in until the Lateral Arm Assembly makes contact with the Horizontal Square Bar and is fully closed. Your Helper will now be able to **slide one of the supplied Safety Sleeves on to the Lateral Arm Assembly until it contacts the Front Bar Connector**. See Figure 3.

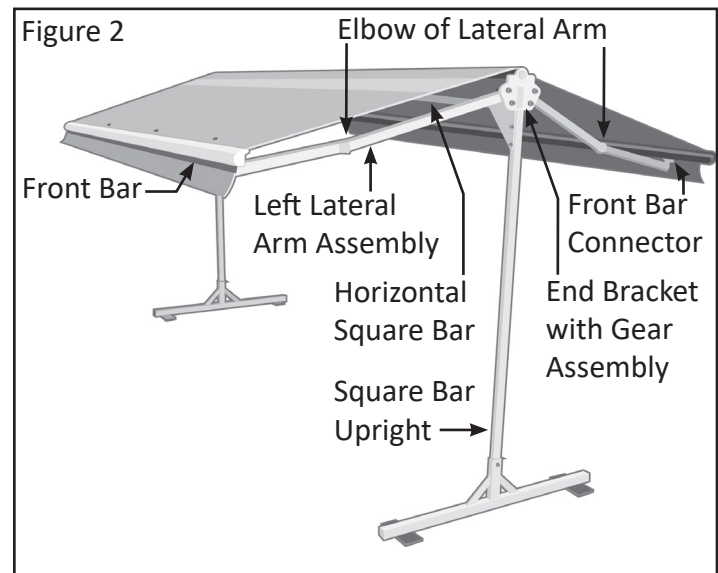
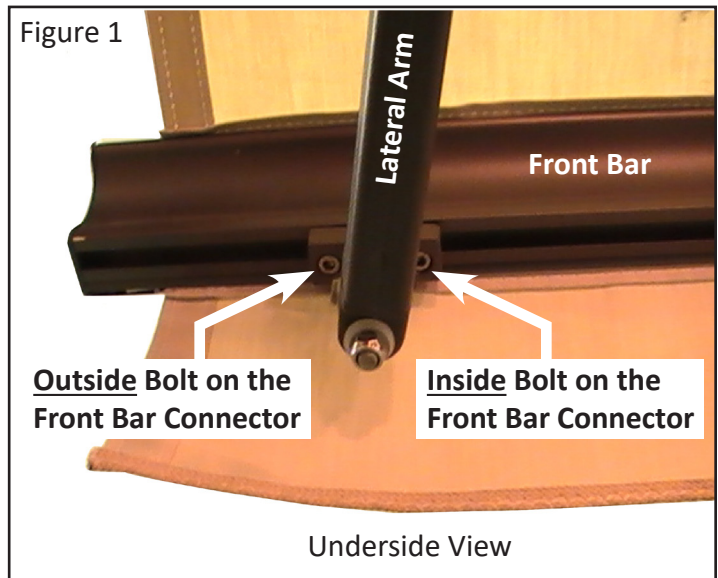

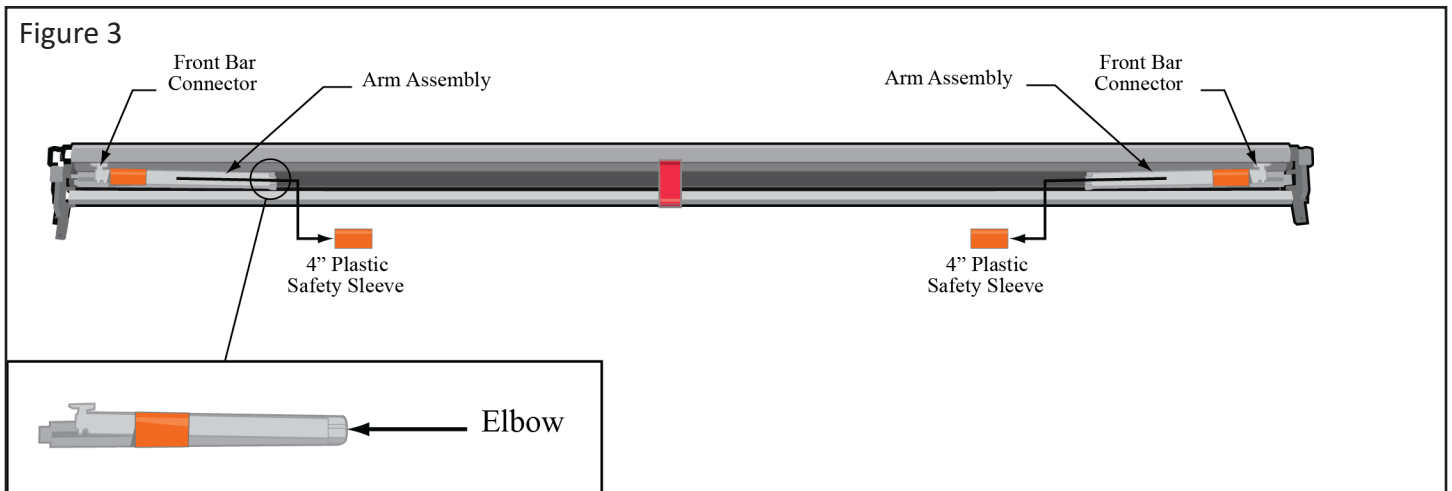

6. Repeat the procedure for the remaining three (3) Lateral Arm Assemblies.

7. Using the Crank Wand, close the Awning completely, if not already closed.

8. While holding the Crank Wand to keep the Awning closed, **slide the supplied Safety Sleeves on all four (4) Lateral Arm Assemblies** until they contact the Front Bar Connector, unless you have already installed the Safety Sleeves on the Arm Assemblies. See Figure 3.

9. Position two (2) Sawhorses approximately eight (8) feet apart.

WARNING: THE FOLLOWING PROCEDURE SHOULD BE ACCOMPLISHED BY FOUR (4) PEOPLE. See Figure 4.

10. One person should be positioned at each Leg Assembly to **prevent the Awning from sliding** as the unit is tipped over.

11. One person should be positioned at each Leg Assembly, and **be able to lift and support the weight** of that end of the Awning.

12. When the helpers are in position, the two (2) people positioned at the ends of the Awning Assembly should tip the Awning over until the Awning is resting on the two (2) Saw Horses. See Figure 4.

13. **On the end of the Awning opposite the Gear Assembly**, locate the Front Bar Connectors that secure the Lateral Arms to the Front Bars and using a 5mm Allen wrench, loosen the **Outside Bolt** on the Front Bar Connector on both of the Front Bars on that end of the Awning. See Figure 5.

14. **On the end of the Awning with the Gear Assembly**, using a $\frac{9}{16}$ " socket and wrench loosen and remove the two bolts that secure the Corner Brace to the Horizontal Square Bar. Put these bolts and locknuts in a safe and clean place. See Figure 6.

15. Use a hammer to tap on the inside edge of the Square Bar Upright (the Leg Assembly) so that the End Bracket moves **approximately ONE (1) INCH away** from its original position, allowing the Square Pin extending out of the gray Roller Cap to become free from where it inserts into the Crank Assembly. See Figure 6. (This will allow the Roller Bar to be moved out of the way so the original Roller Cap can be removed from the Roller Bar and the new one installed into the Roller Bar.)

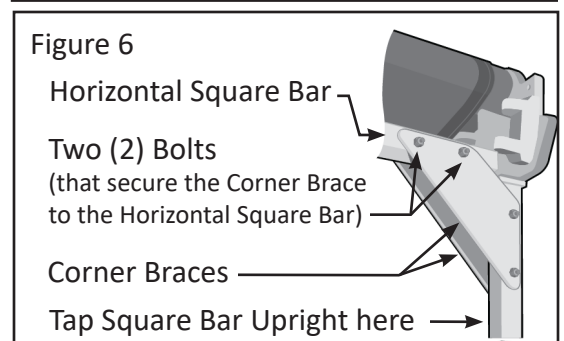
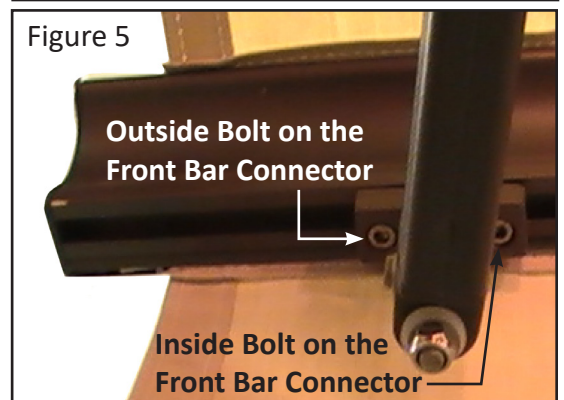
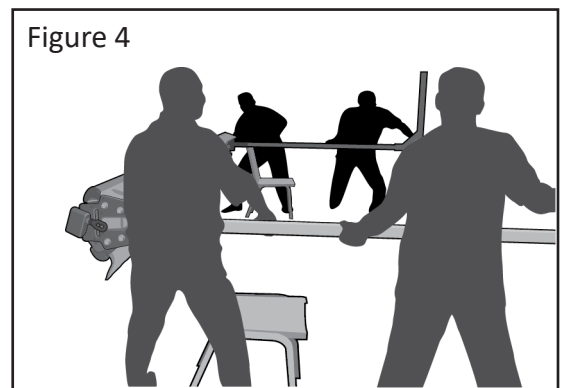

16. If the Fabric is completely rolled up, use the Crank Wand to unroll about three (3) inches of Fabric to allow for moving the Roller Bar into a workable position to remove the Roller Cap. Remove the Crank Wand.

17. **On the end of the Awning opposite the Gear Assembly**, have a helper hold the Roller Bar where it connects to the End Bracket. Do not let the Roller Bar separate from the End Bracket at this end. If separation occurs, be careful to not lose or damage the dark gray bushing that is on the pin end of the Roller Cap.

18. **On the end of the Awning where the Roller Cap (with the Square Pin) is being replaced**, have a helper hold the Roller Bar up and away from the End Bracket, to provide access to the original Roller Cap.

19. While helpers hold the Roller Bar stationary, use the Locking Pliers to clamp onto the Square Pin extending out of the gray Roller Cap. Use the Hammer to tap on the Locking Pliers and remove the Gray Cap from the Roller Bar. See Figure 7.

20. Install the replacement Roller Cap into the Roller Bar, aligning the slot in the Roller Cap with the Fabric Slot in the Roller Bar. See Figure 8.

21. With the aid of your helper, align the Square Pin of the new Roller Cap with the square opening in the Gear Assembly.

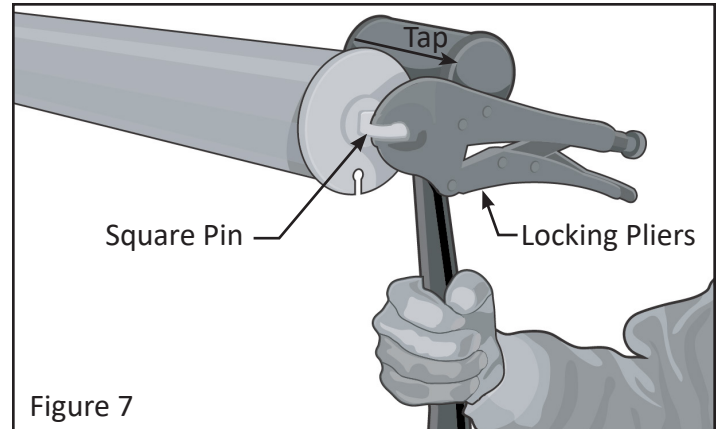

Note: Make sure the dark gray bushing is still on the Roller Cap Pin on the other end of the Roller Bar and it is still in place in the End Bracket.

22. Carefully and gently, tap the outside of the End Bracket and Crank Assembly onto the Square Pin, until the End Bracket is fully seated into the Horizontal Square Bar.

23. Align the holes in the Corner Braces and Horizontal Square Bar and install Bolts and Locknuts removed in Step 14. See Figure 6.

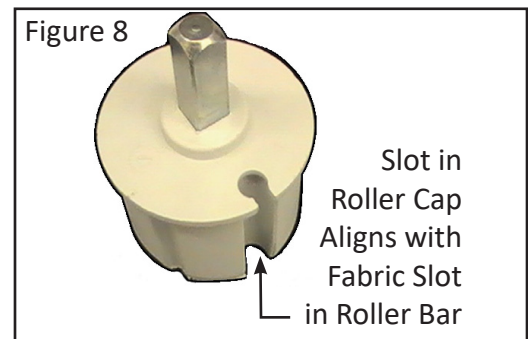

24. **On the end of the Awning opposite the Gear Assembly**, push the Front Bar down until the two sections of the Lateral Arm touch and using a 5mm Allen wrench, tighten the outside bolt on the Front Bar Connector. Repeat this procedure for the outside bolts on the other three (3) Front Bar Connectors.

WARNING: THE FOLLOWING PROCEDURE SHOULD BE ACCOMPLISHED BY FOUR (4) PEOPLE.

25. One person should be positioned at each Leg Assembly to prevent the Awning from sliding as the unit is placed in the upright position.

26. One person should be positioned at each end of the Awning Assembly, and be able to support and lift the weight of that end of the Awning.

27. When the helpers are in position, the two people positioned at the ends of the Awning Assembly should lift the Awning together and tip the unit until the Awning is upright on the Leg Assemblies.

28. Using the Hand Crank, roll up the Fabric on to the Roller Bar so that the Awning is completely closed.

29. Position a step ladder at the Gear Assembly end of the Awning (**Note:** outside the Awning, not under the Awning) and Align with the Elbow of the Left Arm Assembly. See Figure 2.

30. Start with the Left Arm Assembly, grasp the outside edge of the Front Bar and pull it in toward the End Bracket.

31. Continue to hold the Front Bar while one of your helpers slides the Safety Sleeve off of the Arm Assembly.
32. Repeat the procedure for the remaining three (3) Arm Assemblies.
33. On the end of the Awning opposite the Gear Assembly, locate the Front Bar Connectors that secure the Lateral Arms to the Front Bars and using a 5mm Allen wrench, tighten the inside bolt on the Front Bar Connector on both of the Front Bars on that end of the Awning. Repeat for the other three (3) Front Bar Connectors. See Figure 1.
34. Test the Awning for proper operation.