

# Deluxe 6 Foot Flagpole Installation Instructions

**Parts Supplied:** Flagpole assembly, Gold ball, (2) flag clips, mounting bracket with hardware, Flag-stop.

**Tools needed:** Phillips screwdriver, 1/8" drill bit, electric drill, pencil.

**For masonry:** 1/4" masonry drill bit, hammer.

**CAUTION: Failure to follow these instructions can result in PERSONAL INJURY!! Please read these instructions in its entirety before attempting to complete this process.**

**1.** Remove all the components from the package. [The mounting screws may be inside the bracket].

**2.** Determine the desired location for the flagpole mounting bracket, make sure that the bracket is plumbed.

**3.** Using a pencil, make a mark for each of the four screw holes of the bracket on the mounting surface. Set the mounting bracket aside.

**4. For wood:** Using a 1/8" bit, drill 3/4" deep holes at the four marks that you made on the wall.

**For masonry:** Using a 1/4" masonry bit, drill 3/4" deep holes at the four marks that you made on the wall. Install a supplied plastic anchor into each hole and tap it flush to the surface with a hammer.

**5.** Secure the bracket to the wall using the four Phillips screws that are supplied.

**6.** Screw the gold ball onto the top end of the pole, (the end with the upper swivel - see figure 1).

**7.** Slide the flag-stop on the pole from the bottom end, then slide on the lower swivel. The flag-stop should now be located between the upper and lower swivel - see figure 1.

**8.** Attach the flag to the swivels using the 2 flag clips.

**9.** Unscrew the white knob on the side of the bracket enough so that the pole can be completely inserted into the bracket.

**10.** Insert the pole into the mounting bracket. Snug the white knob on the side of the mounting bracket but do not overtighten.

**11.** Position the flag-stop so that it is at least 1" above the lower swivel and orient the screw so that it is facing the ground or facing away from the house. Tighten the screw on the stop by hand only. **DO NOT USE ANY TOOLS TO TIGHTEN THE SCREW ON THE FLAG-STOP.**

**12.** To adjust the angle of the pole, release the wing-nut on the mounting bracket until the teeth are free to turn and secure at the desired angle.

**CAUTION:** To prevent damage to the bracket, make sure that the wing-nut is re-tightened after adjusting the angle of the pole.

For Technical Assistance call  
SunSetter Products  
1-800-670-7071

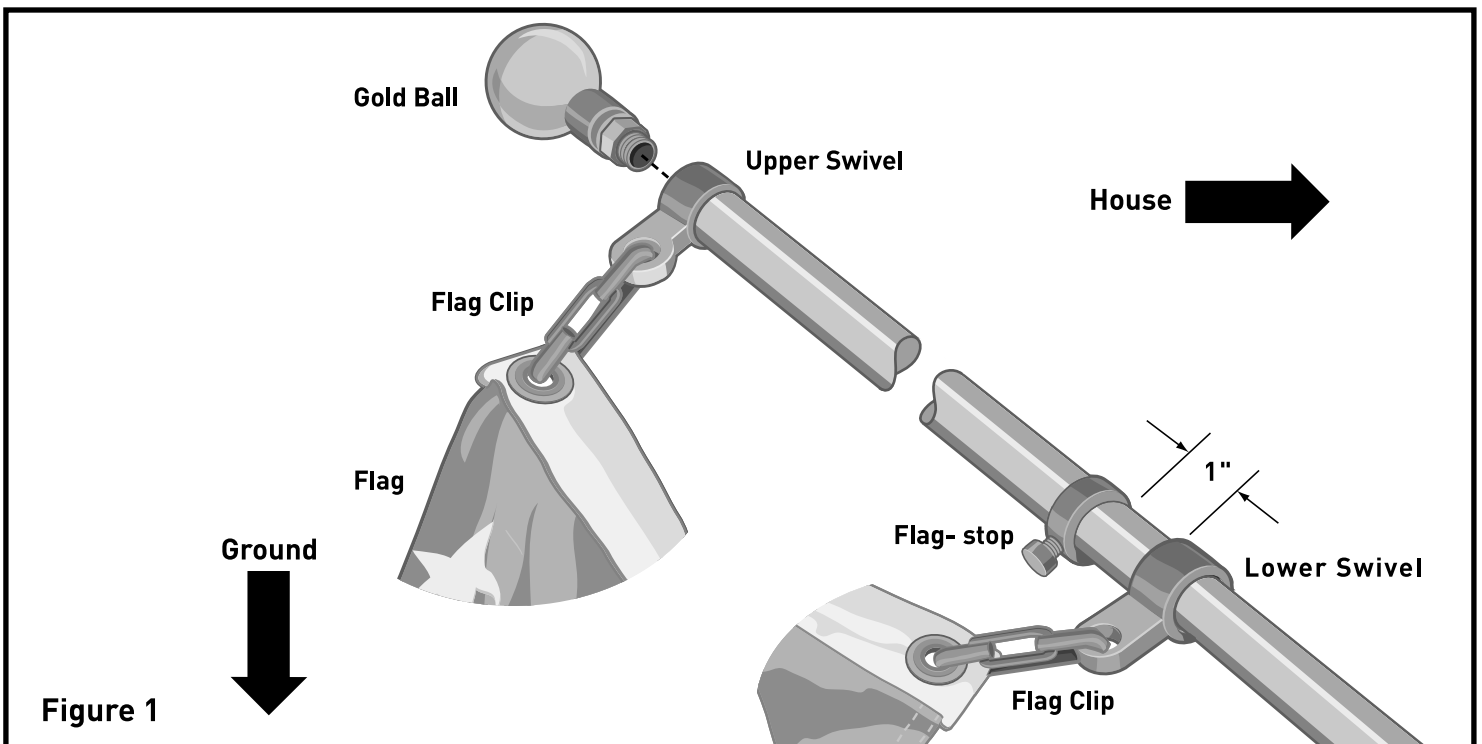
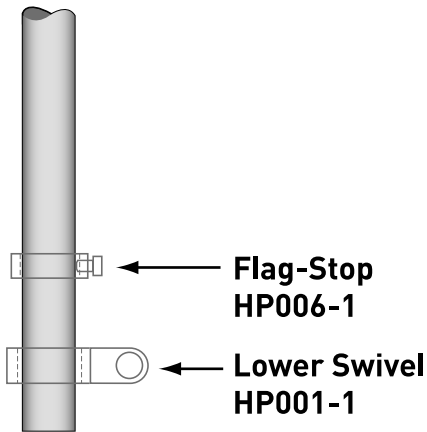
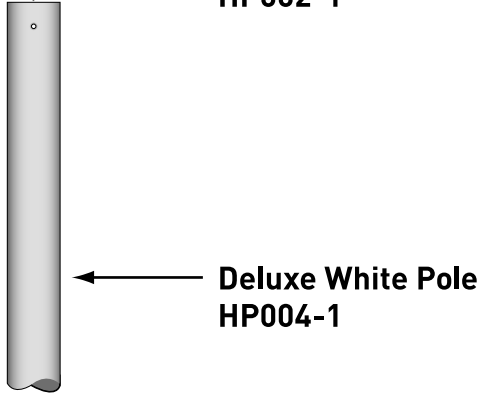
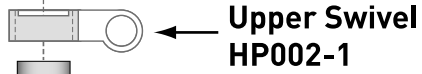
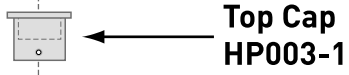
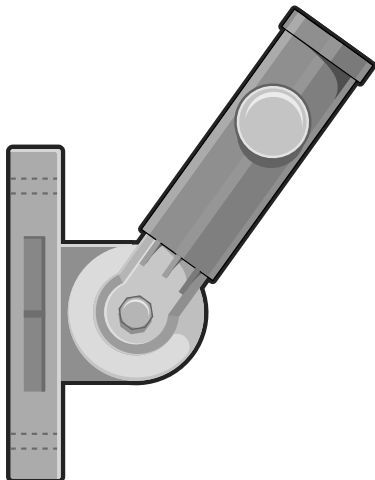

Figure 1



Deluxe Mounting Bracket  
HP007-1



Clip  
FP3011-2  
Qty 2

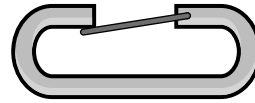

Mounting Bracket Knob  
White  
HP009-1

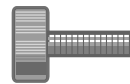

Mounting Bracket Hardware  
HP008-1  
Qty 4 ea



Flag  
FP1012

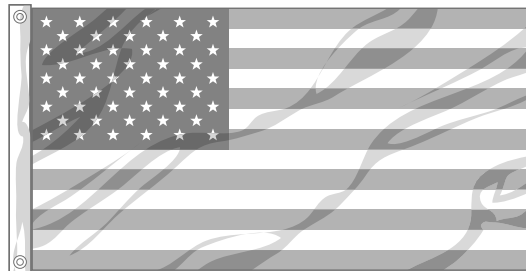

## **SunSetter Flagpole 5-yrs Manufacturer's Limited Warranty**

This limited warranty is extended by the manufacturer, SunSetter Products Limited Partnership, 184 Charles Street, Malden, Massachusetts 02148 to the original purchaser and may not be assigned or transferred to subsequent owners. This Warranty applies only to SunSetter Flagpoles purchased and installed in the US. To activate this warranty or to receive coverage, the original purchaser must fill out and mail to SunSetter Products the registration card included with the product, or submit the on-line registration form at [www.myflagpole.com](http://www.myflagpole.com) or show SunSetter products a dated proof of delivery (copy of original purchase receipt) when submitting a claim. The purchaser agrees and acknowledges that this Warranty agreement constitutes an executory contract.

Under this Warranty, the SunSetter Flagpole has a five (5) year limited warranty, from the date of the original purchase, against manufacturer's defects. Subject to the terms and conditions set forth herein, SunSetter Products will furnish replacements for parts found by SunSetter Products to be defective in design, manufacture or assembly, provided that the flagpole is not subjected to excessive winds.

### **A. WHAT IS NOT COVERED UNDER THIS WARRANTY**

1. Any failure or damage of the components that results from normal wear and tear, negligence, misuse, accident, improper installation or stormy weather is not covered by this Warranty.
2. Labor charges connected with installation of replacement parts are not covered by this Warranty.
3. Freight expenses to and from SunSetter Products in shipping damaged or replacement parts are not covered by this Warranty and must be paid by the purchaser.
4. This Warranty is exclusive to the Flagpole and does not apply to the flag.

### **B. GENERAL PROVISIONS AND LIMITATIONS**

**1. THE WARRANTY GRANTED HEREIN IS THE EXCLUSIVE REMEDY FOR THE PURCHASER. SUNSETTER PRODUCTS MAKES NO OTHER WARRANTIES TO THE PURCHASER, EXPRESS, STATUTORY, IMPLIED OR OTHERWISE AND ALL IMPLIED WARRANTIES, INCLUDING WITHOUT LIMITATIONS, IMPLIED WARRANTIES OF MERCHANTABILITY AND FITNESS FOR A PARTICULAR PURPOSE, ARE HEREBY DISCLAIMED.**

**2. TO THE EXTENT PERMITTED BY LAW, SUNSETTER PRODUCTS SHALL HAVE NO LIABILITY TO THE PURCHASER OR ANY OTHER PERSON FOR INCIDENTAL, SPECIAL, CONSEQUENTIAL, INDIRECT OR SIMILAR DAMAGES OF ANY KIND OR NATURE WHATSOEVER, WHETHER ARISING OUT OF BREACH OF WARRANTY OR OTHER BREACH OF CONTRACT, NEGLIGENCE OR OTHER TORT, OR OTHERWISE, EVEN IF SUNSETTER PRODUCTS SHALL HAVE BEEN ADVISED OF THE POSSIBILITY OR LIKELIHOOD OF SUCH POTENTIAL LOSS OR DAMAGE. IN NO EVENT SHALL SUNSETTER PRODUCTS BE LIABLE FOR LOSS OF PROFITS AND/OR DAMAGES.**

3. Some states do not allow limitations on how long an implied warranty lasts, or do not allow the exclusion or limitation of incidental or consequential damages, so the above limitations may not apply to you.

4. This warranty gives you specific rights, and you may have other rights, which vary from state to state.

