



For Technical Support visit us at www.sunsetter.com/ownerscorner
or Call Toll Free 800-670-7071 • Fax 877-224-4944

Solar Panel Assembly Replacement Instructions

*** Helper Needed ***

Tools Needed: 3mm Allen wrench, $\frac{5}{64}$ " Allen wrench and a flat blade screwdriver.

Parts Supplied: Solar Panel Replacement, 4 mm Allen set screw, 4 mm Allen wrench.

**WARNING: FAILURE TO FOLLOW THESE INSTRUCTIONS CAN RESULT IN PERSONAL INJURY!
PLEASE READ THESE INSTRUCTIONS COMPLETELY BEFORE PERFORMING THIS PROCEDURE.**

1. Close your EasyShade completely, if possible.
2. Disconnect the Power Cord from the Solar Panel.

Note: If a Remote Wall Bracket (see Figure 1) is used to mount the Solar Panel direct to the wall (see Figure 2) instead of mounting directly on the EasyShade Housing, skip ahead to Appendix A.

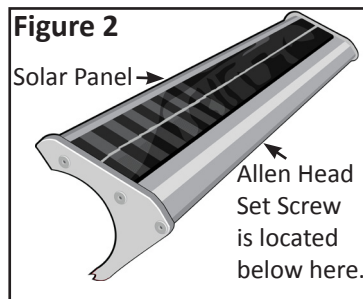
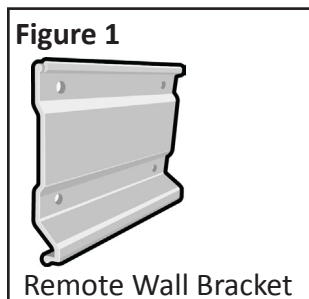

3. Remove the Cable Guide Stops ($\frac{5}{64}$ " Allen wrench) from the bottom of each Vinyl Coated Cable, on each side of the EasyShade. See Figure 2.

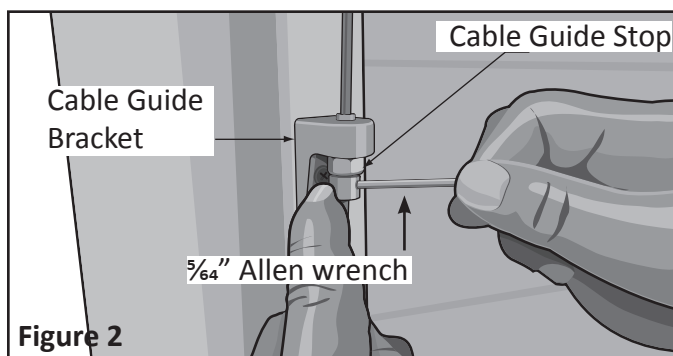

4. Pull the Vinyl Coated Cable out of the Guide Holes in each end of the EasyShade drop down panel. See Figure 3.

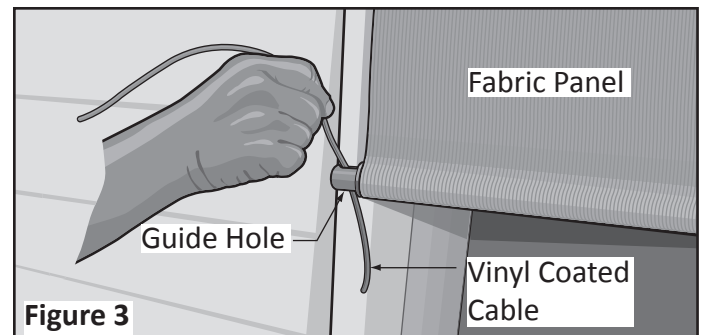

5. Coil the Vinyl Coated cable and secure with a piece of masking tape. See Figure 4.

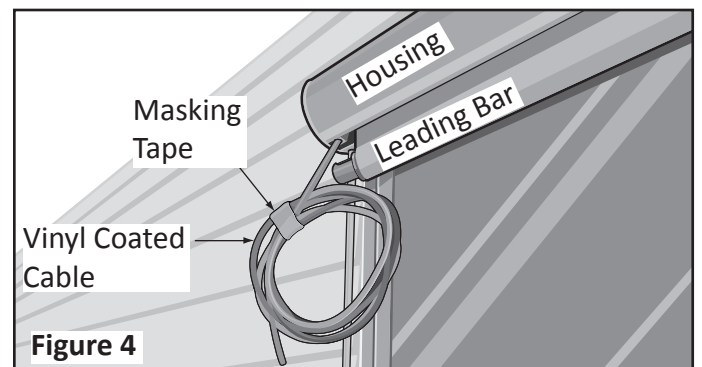

Note: Step 6 requires access to the Mounting Brackets for removal of the Housing from the house. If the Fabric Panel can not be retracted out of the way, have a helper assist you in rolling the Fabric Panel around the bottom Leading Bar, until the rolled up Fabric and Leading Bar meet the Housing, then secure it safely in place.

- While your helper supports the EasyShade, loosen the 3 mm Allen head Set Screws, located on each Mounting Bracket (see **Figure 5**). With the aid of your helper, carefully remove the EasyShade from the Brackets and place it in your work area.

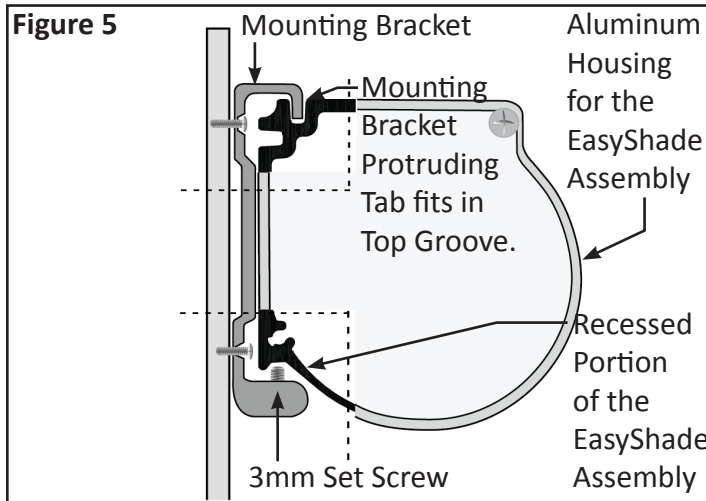

- Using a 4 mm Allen wrench, remove the Allen head Set Screw (see **Figure 9**) securing the Solar Panel to the EasyShade Housing. See **Figure 2** for Set Screw location, under the Solar Panel.

WARNING: HAVE A HELPER HOLD THE EASYSHADE HOUSING STILL, WHILE REMOVING THE SOLAR PANEL. FAILURE TO DO SO CAN RESULT IN DAMAGE TO THE EASYSHADE AND/OR PERSONAL INJURY.

- Insert a flat blade screwdriver into the Slot behind the top of the Solar Panel, where it snaps on to the top of the EasyShade Housing. See **Figure 6**.

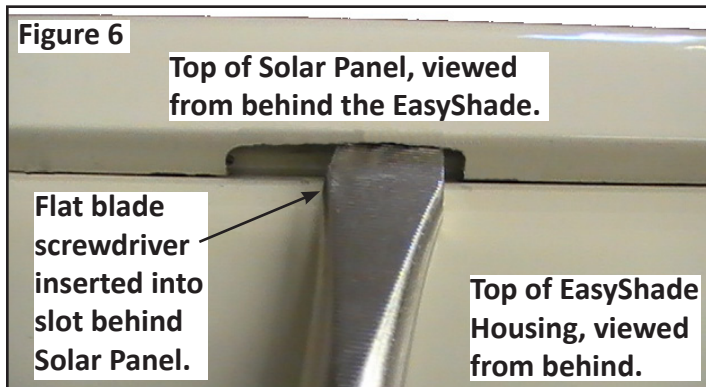

- With the screwdriver inserted into the Slot, pry the Solar Panel away from the EasyShade Housing, until the Panel separates from the Housing. See **Figure 7**.

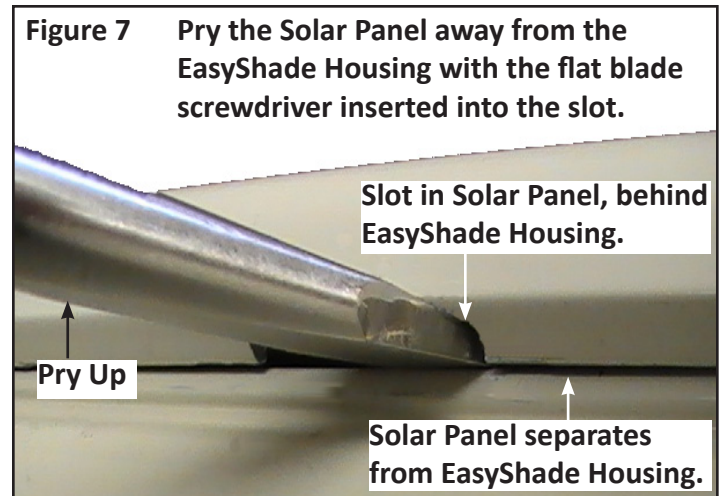

- Set the Solar Panel aside.
- Remove the replacement Solar Panel Assembly from packaging.
- Connect the Power Cord from the replacement Solar Panel to the Motor. See **Figure 8**.

Note: The Connectors are Keyed to ensure proper alignment of Pins in the Cable Connectors.

- Secure the ends together using the Screw Locking Mechanism on the Connectors. See **Figure 8**.
- Route the Power Cable out of the Solar Panel Assembly, through the opening in the End Cap. See **Figure 8**.

Note: When positioning the Solar Panel on the Housing, route the Power Cable that is connected to the Motor behind the housing. Move the Solar Panel far enough away to remove slack in the Power Cable. Total length of the combined Cable is about four feet. For narrow EasyShades, excess Cable can be tucked behind the Housing.

Note: A brief test of the replacement Solar Panel is suggested before mounting the EasyShade into the Brackets, on the house.

15. Test the replacement Solar Panel.
 - a. On the handheld Remote Transmitter, press the **UP** or **DOWN** button, release it, then press the **"my"/Stop** button right away.
 - b. The Motor should move briefly, then stop.
 - c. If the Motor moves, the new Solar Panel is working properly.
 - d. If the Motor does not move, call SunSetter Technical Support at **800-670-7071** for further instructions.
16. Attach the Solar Panel to the Easy Shade Housing.
 - a. The bottom edge of the Solar Panel hooks under the front of the Fabric Panel Opening of the EasyShade Housing. See **Figure 8**.
 - b. Press the top of the Solar Panel firmly over the top front edge of the Housing, until it snaps firmly into place. See **Figure 8**.

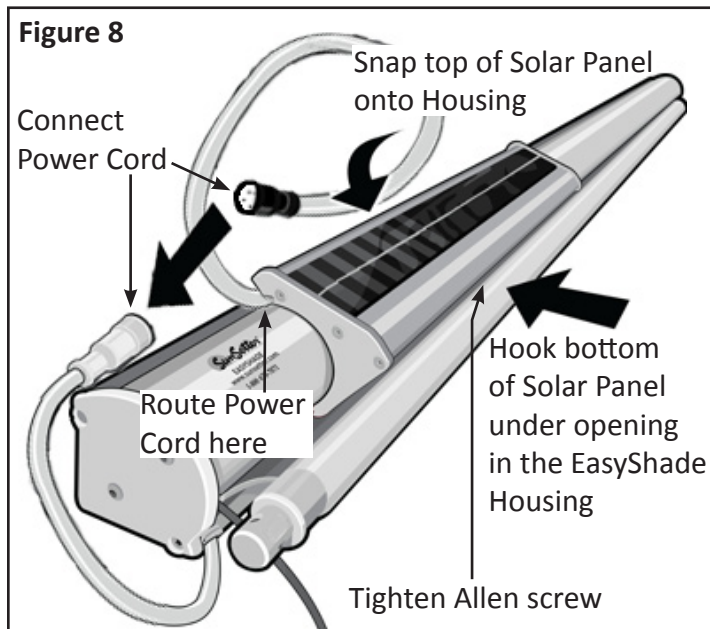

17. Secure the Solar Panel to the EasyShade Housing by inserting and tightening the provided Allen set screw into the threaded opening under the bottom edge of the Solar Panel. See **Figure 9**.

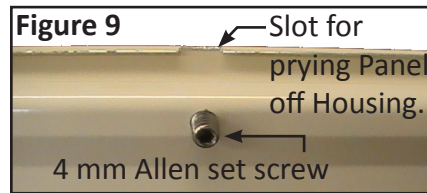

18. With your helper, lift the EasyShade Assembly up to the installed Mounting Brackets and insert the top groove of the EasyShade assembly onto the protruding tab on the Mounting Brackets. See **Figure 5**.
19. While maintaining upward pressure to keep the top groove of the EasyShade Assembly on the tab of the Mounting Brackets, press the EasyShade Assembly toward the Mounting Bracket and be sure that the set screw is aligned in the recessed portion of the EasyShade assembly. See **Figure 5**.
20. Tighten the set screw in each Mounting Bracket until the EasyShade assembly is secure.
21. At each end of the EasyShade Housing Assembly uncoil the Vinyl Coated Cable. Allow the coiled cable to hang flat against the mounting surface.
22. Insert the Vinyl Coated Cable located at each end of the Housing Assembly through the guide holes at each end of the EasyShade Drop Down Fabric Panel. See **Figure 3**.
23. Place the lower end of one of the Vinyl Coated cables through the hole in the Cable Guide Bracket and from the bottom slide one of the Cable Guide Stops onto the Vinyl Coated Cable and secure in place with the $\frac{5}{64}$ " Allen wrench. Repeat for the other side of the EasyShade. See **Figure 2**.
24. Ensure the Vinyl Coated Cables are tight. Adjust the tension using a $\frac{7}{16}$ " open end wrench as follows. On each of the Cable Guide Stops you will find $\frac{7}{16}$ " nut, by turning the nut counter clockwise you can tighten the cable.

Note: DO NOT OVER TIGHTEN THE CABLE.

25. Connect the Motor Power Cord to the Solar Panel.
26. Test EasyShade for proper operation. Enjoy.

APPENDIX A

REMOVAL OF SOLAR PANEL FROM WALL MOUNT BRACKET

1. Disconnect the Power Cable between the Solar Panel and EasyShade Motor.
2. Loosen the Allen Set Screw (see **Figure 2**) under the Solar Panel.
3. Carefully slide the Solar Panel to the left or right side, until it separates from the Bracket.

CAUTION: If the Solar Panel does not easily slide off the Wall Mount Bracket, nudge it gently. Do not use a hammer to bang the Solar Panel Assembly, as permanent damage may occur.

WARNING: WHEN USING A LADDER OR ANY OTHER CLIMBING DEVICE, YOU MUST USE EXTRA CAUTION WHEN SLIDING THE PANEL OFF THE BRACKET. WE RECOMMEND TO POSITION THE CLIMBING DEVICE TO THE SIDE TOWARD WHICH YOU WILL BE REMOVING THE PANEL. IT IS HIGHLY RECOMMENDED TO HAVE A HELPER SECURE THE CLIMBING DEVICE. FAILURE TO DO SO COULD RESULT IN A FALL AND IN PERSONAL INJURY.

INSTALLATION OF SOLAR PANEL TO WALL MOUNT BRACKET

1. Connect the Power Cable between the Solar Panel and EasyShade Motor.
2. Center the Solar Panel in front of the Mounting Bracket.
3. Set the bottom of the Solar Panel against the house, so the Allen Set Screw (see **Figure 2**) points up, toward the bottom of the Mounting Bracket.
4. Hook the lower edge of the Panel under the lower edge of the Mounting Bracket.
5. Press the top of the Solar Panel over the top of the Mounting Bracket, so the top Lip of the Panel snaps onto the top Groove of the Bracket.
6. Tighten the Allen Set Screw, under the Solar Panel, ensuring the Solar Panel is secured to the Bracket and will not slide either left or right. See **Figure 2**.
7. Test EasyShade for proper operation. Enjoy.