



RETRACTABLE AWNINGS

For Technical Support visit us at www.sunsetter.com/ownerscorner or Call Toll Free 800-670-7071 • Fax 877-224-4944

Motorized and Motorized PRO Awning Sunea Motor Replacement Instructions

*** Helpers needed ***

Tools needed: 3/16" wrench, Phillips screwdriver, 3 mm Allen wrench, two step ladders, 13 mm or 1/2" wrench, small hammer (optional).

WARNING: FAILURE TO FOLLOW THESE INSTRUCTIONS CAN RESULT IN PERSONAL INJURY!! PLEASE READ THESE INSTRUCTIONS IN ITS ENTIRETY BEFORE ATTEMPTING TO COMPLETE THIS PROCESS.

PLEASE NOTE THAT LEFT AND RIGHT REFERENCES ARE AS YOU ARE FACING THE HOUSE.

1. Open the Awning to the fully extended position.

2. Unplug the power cord from the wall outlet.

Note: For Awnings that have a SunSetter Aluminum Hood installed, on the same side as the Motor, remove the Hood End Plate. See Figure 1.

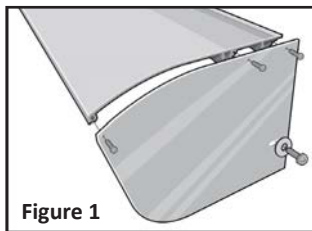

3. Using the Manual Crank Wand, continue to unroll the Fabric until you expose the Fabric Slot in the Roller Bar and create maximum slack in the Fabric. See Figure 2.

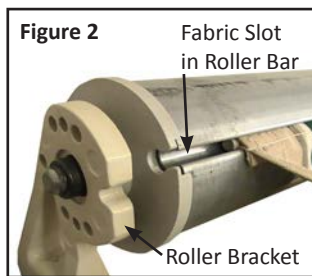

4. Have one helper hold the Roller Bar near the Roller Bracket on the side that is opposite of the Motor. **This is necessary to keep the Roller Bar from coming out of the Roller Bracket while the Motor is unbolted from the other side.** See Figure 2.

Note: The Roller Bar can be removed from between the Roller Brackets if more space is needed to remove and replace the Motor. Be careful to not lose the Gray Bushing on the Pin at the end of the Roller Bar. The Helper(s) must hold and stabilize the Roller Bar with care.

5. While your helpers support both ends of the Roller Bar, remove the two 1/4-20 Hex Bolts and Washers that connect the Motor to the Roller Bracket. **Mark the threaded holes in the Roller Bracket that the bolts are removed from.** See Figure 3.

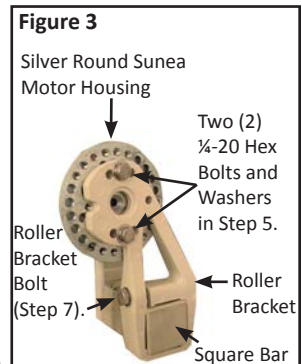

6. While a helper supports the Roller Bar near the Motor, slide the Motor Assembly out of the Roller Bar. See **Note at Step 4.**

7. If replacing an RTS Motor (Black Square Motor Housing) with a new Sunea Motor (Silver Round Motor Housing), loosen the Bolt on the Roller Bracket that held the Motor, using a 13 mm or 1/2" wrench. Slide the Roller Bracket 1/8" toward the end of the Square Bar. Tap the Bracket with a small hammer, if necessary. See Figure 3.

8. Insert the new Motor into the Roller Bar, **aligning the cream colored slots** in the black Tube Driver and Crown Gear with the Fabric Slot in the Roller Bar. See Figure 4.

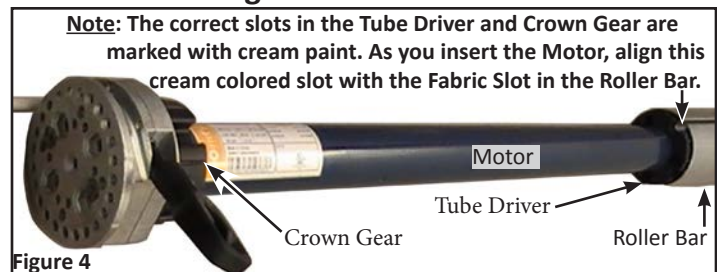

Note: The threaded holes on the replacement Motor Plate are marked to indicate the holes to use during reassembly. Align these holes with the holes noted or marked on the Roller Bracket, in Step 5.

9. Replace the Roller Bar between the two Roller Brackets.

Note: Ensure the Gray Bushing is on the Round Pin of the End Cap before sliding it into the Roller Bracket (on the end opposite the Motor).

Ensure the End Cap of the Roller Bar is in contact with the Roller Bracket on the end opposite the Motor. See Figure 5.

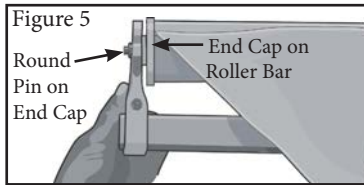

10. Slide the Roller Bracket, if loosened in Step 7, up against the Motor End Plate, for a snug fit.

11. Attach the Motor to the Roller Bracket with the two ¼-20 hex bolts and washers. See Figure 3.

Note: Be very careful not to cross-thread the hex bolts; start the bolts by hand and finish tightening them with the ⅜" wrench. Using a 13 mm or ½" wrench, tighten the bolt on the Roller Bracket.

12. Remove the Override Crank from your old Motor using a 3 mm Allen wrench. Insert the Override Crank into the new Motor from the bottom of the groove in the Motor so the Override Crank loop faces downward. Secure the Override Crank from the top with the Allen Cap Bolt and Washer. See Figure 6.

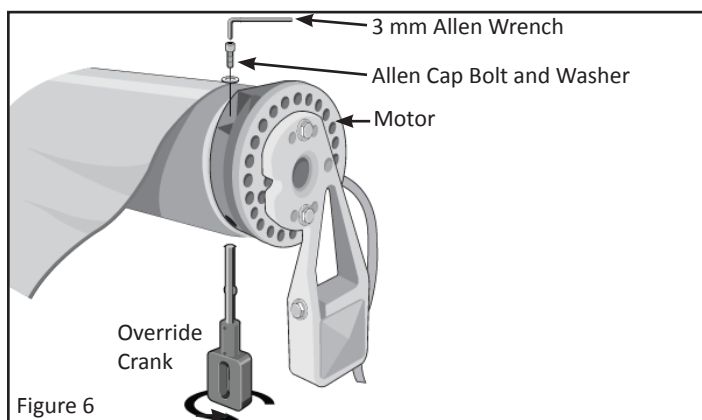

Note:

- For LEFT side Motor, the Override Crank should be facing toward the Front of the Awning and the Motor Cord should be facing up. See Figure 7.
- For RIGHT side Motor, the Override Crank should be facing toward the Front of the Awning and the Motor Cord should be facing toward the ground. See Figure 8.

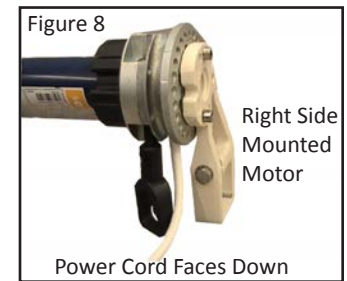
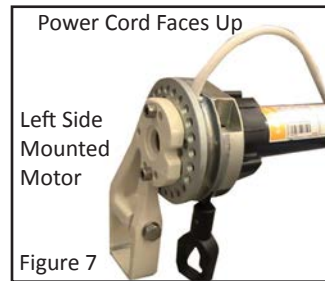

13. Center the Fabric on the Roller Bar and on the Front Bar. Hold the Fabric snug across the length of the Roller Bar, ensuring it rolls up evenly.

14. Use the Manual Crank Wand to slowly roll the Fabric onto the Roller Bar, until the Awning is approximately half-way closed.

15. Reinstall the Hood End Plate if removed.

16. Plug the Power Cord back into the wall outlet.

17. To program the new Motor to your existing Remote Transmitter and set the new Closed and Open stops for your Awning, go to **Appendix A**.

18. Test the Awning for proper operation.

19. Add Additional Control Devices:

- To add another Remote Transmitter or an All Weather Remote Transmitter, go to the section titled "To Add an Additional Control Device" located at the end of **Appendix A**.
- To add a Wireless Wind Sensor or Wireless Wall Switch, go to **Page 4**.

Note: If the old Motor needs to be returned to SunSetter Products, please find a PrePaid UPS Return Label attached to the shipping tube of the replacement Motor.

Appendix A

This procedure describes the actions needed to establish communication between the new Motor and the Remote Transmitter that will be used to control your Awning and set the new CLOSE and OPEN positions.

Tools needed: A pen or similar pointing device is needed to press and hold the Programming Button.

WARNING: THIS PROCEDURE MUST BE FOLLOWED THOROUGHLY AND COMPLETELY.

Front View



Rear View



Note: Using the Channel Selector Button, set the Remote to the preferred Channel.

1. Press and Hold the **CLOSE** and **OPEN** buttons together until the Awning jogs.
Note: If your Awning Motor is installed on the **left** as you face the house continue with Step 3. If your Awning Motor is installed on the **right** as you face the house continue with Step 2, to change the direction of the Motor rotation.
2. To change the Motor direction Press and Hold the **my** button until the motor jogs. The **CLOSE** button should cause the Awning to move in the close direction, with the Fabric rolling on to the top of the Roller Bar.
3. Use the **CLOSE** button to move the Awning to the desired closed position.
4. Press and Hold the **my** and **OPEN** buttons simultaneously; release them when the Awning begins to open.
5. Press the **my** button to Stop the Awning at the desired open position.
6. Use the **CLOSE** and **OPEN** buttons to make desired adjustments to the open position.
7. Press and Hold the **my** and **CLOSE** buttons simultaneously; release them when the Awning begins to move. The Awning stops at the close position set in step 3.
8. Press and Hold the **my** button; release when the Awning begins to move. The Awning will move slightly, then stop on its own.
9. Press and Hold the **Programming Button**, wait for awning to jog.
10. Process complete. Test the Awning for correct open and close settings.

Note: To only **adjust** the open or close settings, use the following procedures.

TO CHANGE THE OPEN LIMIT:

Move the Awning to its current open position and let it stop on its own. Press the **CLOSE** and **OPEN** buttons together until the Awning jogs, then release. Adjust to a new open position. Press the **my** button until the Awning jogs, then release. Check the new Open setting.

TO CHANGE THE CLOSE LIMIT:

Move the Awning to its current close position and let it stop on its own. Press the **CLOSE** and **OPEN** buttons together until the Awning jogs, then release. Adjust to a new close position. Press the **my** button until the awning jogs, then release. Check the new close setting.

To Add an Additional Control Device to the Awning;

- A. Press the Programming button on the back of the Remote Transmitter that controls your Awning and wait for a short movement or back and forth jog of the Motor.
- B. Press the Programming button on the Additional Control Device and hold until a short movement or jog of the Motor occurs.

Test the added Device. The Device can be removed by following the same two steps.

Add a Wireless Wind Sensor

1. Remove the Wireless Wind Sensor Housing from the Mounting Plate on the Awning. See **Figure 1**.
 2. Remove the Sensor Body from the Sensor Housing using a small flat blade screwdriver. See **Figure 2**.
 3. Press the Programming Button on the back of the **Remote Transmitter that operates the Awning** (See **Figure 3**) until the Motor “jogs”. A “jog” is a short back and forth movement of the motor.
 4. Press the Programming Button located inside the Sensor (See **Figure 3**) until the Motor “jogs,” then release. **The LED on the Sensor Body will blink.** If the LED does not blink, replace the two AAA batteries, unplug the motor then plug it back in, then restart this procedure at **Step 3**.
 5. Replace the Wind Sensor **on the Mounting Plate**.
 6. Shake the Awning Front Bar up and down (lift the Front Bar approximately one foot, then drop it) quickly 3 - 5 times in a row (for approximately 12 seconds) to simulate the effect of strong wind; this should cause the Awning to automatically close. If the Awning automatically closes, this means the sensor is set correctly.
- Note: The Awning Motor will not accept a command from the Remote Transmitter for up to 1 minute after the Wireless Wind Sensor has retracted the Awning.**
7. If the Awning does not close automatically, repeat **Step 6** by strongly shaking the Front Bar up and down quickly 3 to 5 TIMES IN A ROW. **To shake the Front Bar, lift the Bar until strong resistance is met, then allow the Bar to drop freely. Repeat quickly.** If the Awning still does not close automatically, repeat **Steps 1 to 6** with a **NEW SET OF BATTERIES**. If the Awning still does not close automatically, call Customer Service at **800-670-7071**.

WARNING: YOU MUST BE CERTAIN THAT THE WIRELESS WIND SENSOR IS INSTALLED, PROGRAMMED AND OPERATING PROPERLY. FAILURE TO DO SO MAY RESULT IN THE WIRELESS WIND SENSOR NOT BEING ABLE TO CLOSE YOUR AWNING DURING WINDY CONDITIONS, WHICH COULD CAUSE DAMAGE AND PERSONAL INJURY. IF THE MOTOR DIRECTION IS REVERSED THE SENSOR WILL EXTEND (OPEN) THE AWNING IN WINDY CONDITIONS, INSTEAD OF CLOSING IT.

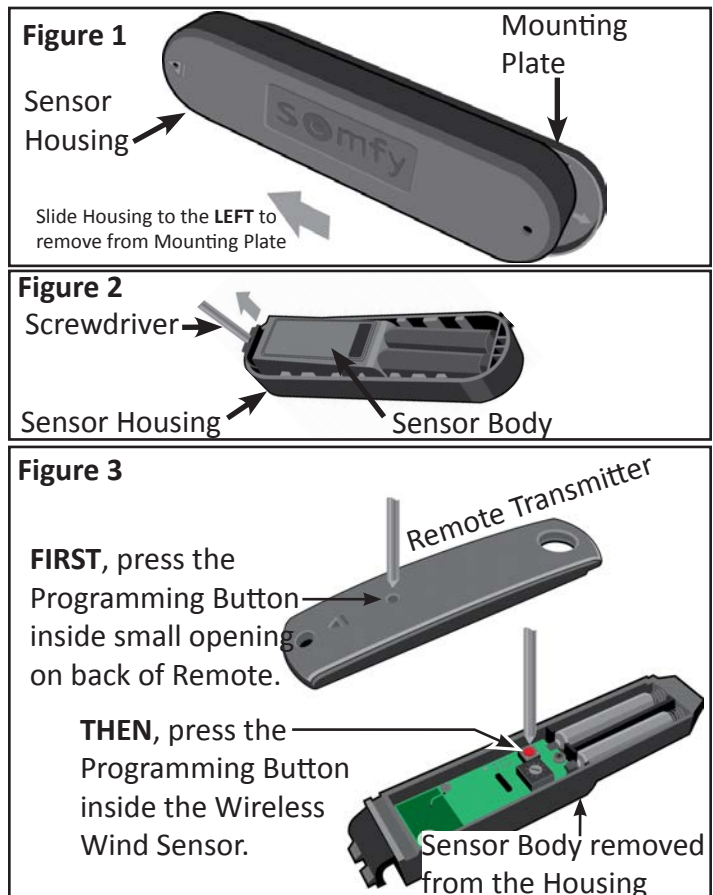

Add a Wireless Wall Switch

1. Press the Programming Button (recessed inside the opening) on the rear of the Remote Transmitter (see **Figure 1**), that controls your Awning until it responds with a movement.
2. Briefly press the Channel Select Button for the channel of the Multi-Channel Wall Switch that you want to use to control your Awning (see **Figure 2**). The adjacent LED will light up for 10 seconds. Using a paper clip or similar device, press the Programming Button located on the Wall Switch until the Motor responds with a movement.
3. Your Wall Switch is set to operate your SunSetter Awning. Test the Awning now for proper operation.

